

## Athena Stool

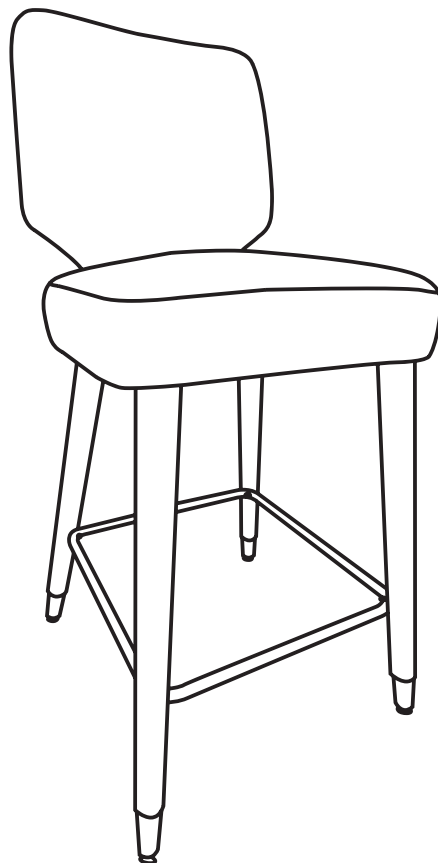

# Athena Stool

---





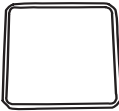
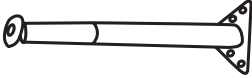
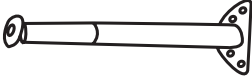

## ASSEMBLY INSTRUCTIONS



## PARTS LIST

LABEL	PICTURE	DESCRIPTION	QTY
<b>A</b>		<b>Back</b>	<b>1</b>
<b>B</b>		<b>Seat</b>	<b>1</b>
<b>C</b>		<b>Footrest</b>	<b>1</b>
<b>D</b>		<b>Front Leg</b>	<b>2</b>
<b>E</b>		<b>Back Leg</b>	<b>2</b>

## HARDWARE

<b>F</b>	 16	<b>Spacer</b>	<b>20</b>
<b>G</b>	 10	<b>Spacer</b>	<b>20</b>
<b>H</b>	 M6x55	<b>Screw</b>	<b>20</b>
<b>I</b>	 M6x35	<b>Screw</b>	<b>4</b>
<b>J</b>	 M6	<b>Wrench</b>	<b>1</b>
<b>K</b>	 M5	<b>Wrench</b>	<b>1</b>

### BEFORE BEGINNING ASSEMBLY:



*Read instructions cover to cover*



*Have two adults on hand for assembly*



*Do NOT assemble on flooring or carpet. Assemble on a clean non-marring surface (ex: packing foam)*



*Save all packaging until assembly is completed Need a part?  
Call TOV at 516-888-3355 or email [service@tovfurniture.com](mailto:service@tovfurniture.com)*

# ASSEMBLY STEPS

## STEP 1

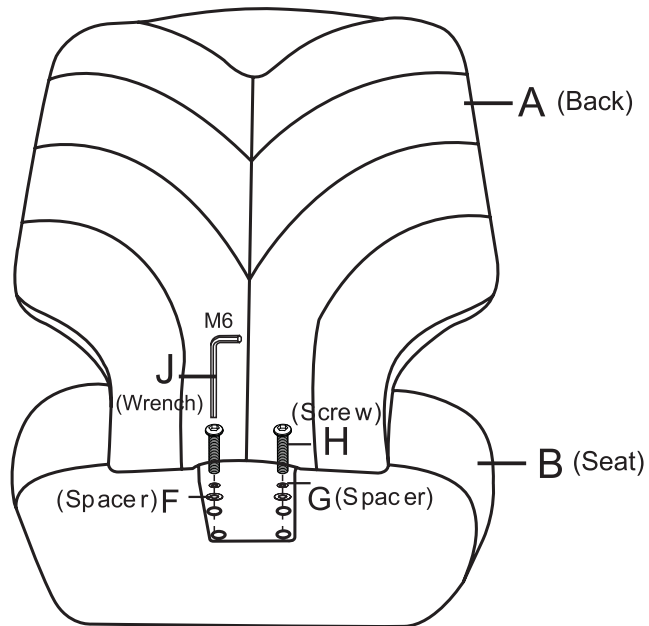

## STEP 2

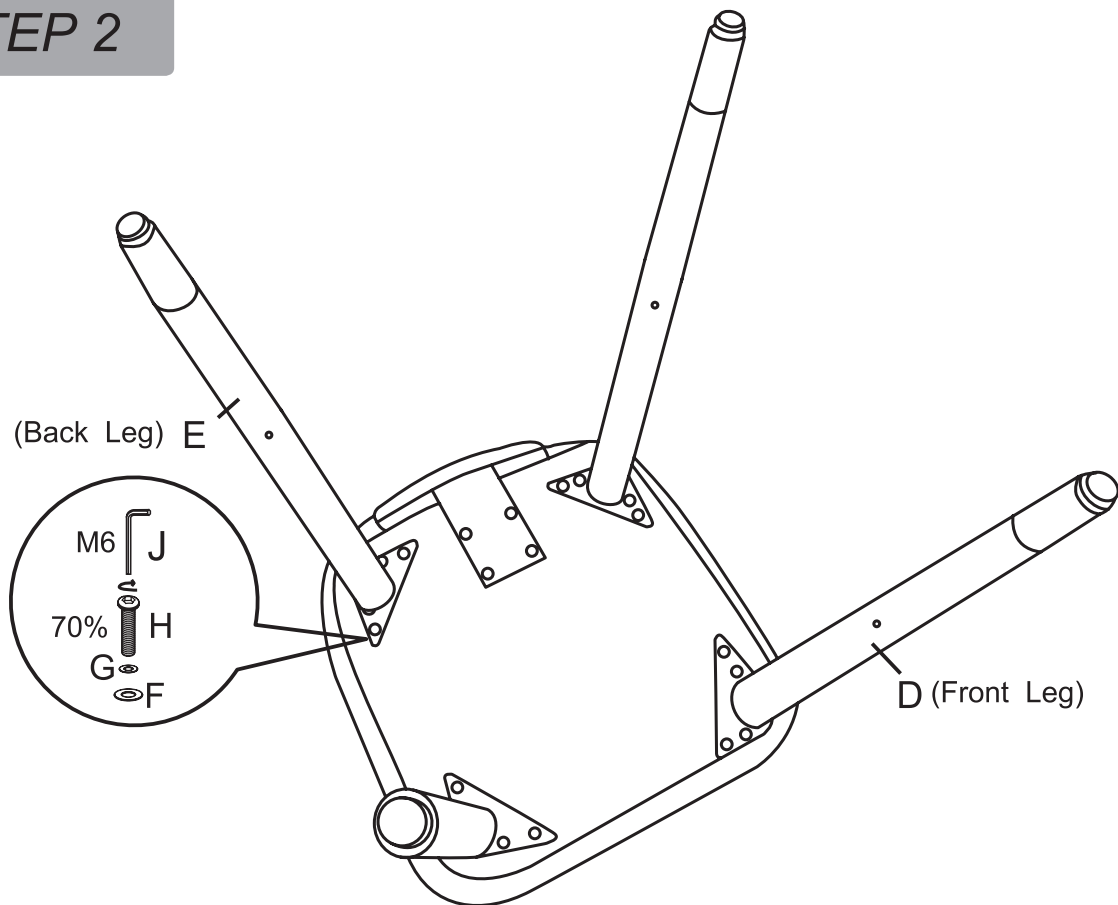

Step 2: Do not tighten the screws fully at this point.

# ASSEMBLY STEPS

## STEP 3

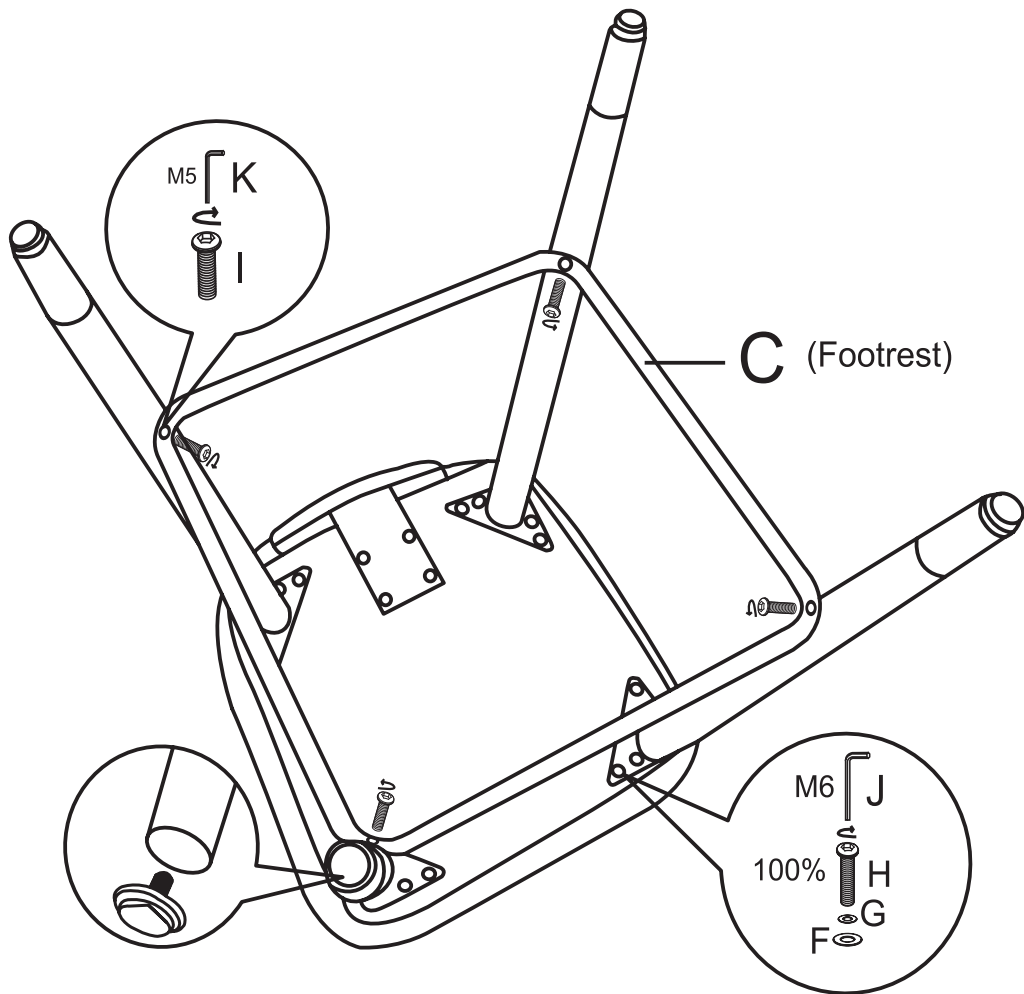

You can adjust the floor glides to ensure the stool is steady

Step 3: Screws can now be fully tightened.

## **CARE & MAINTENANCE**



**Do not put hot items directly on furniture surface.**



**Do not clean furniture with harsh cleansers or polish.**



**Dust and pick up spills using a clean, non-colored, lint-free cloth.**



**Stains may be removed with mild soap solution and a damp cloth.**



**Do not place furniture under direct sunlight.**



**Do not place furniture near heating or cooling vents.**



**Do not write on furniture without a padded barrier to protect the surface.**



**Do not place furniture outside, for indoor use only.**