

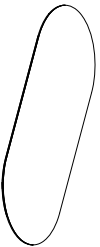

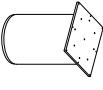



## PARTS LIST

LABEL	PICTURE	DESCRIPTION	QTY
A		TOP	1
B		LEGS	2

## HARDWARE

LABEL	PICTURE	DESCRIPTION	QTY
C		BOLT M6x20	20
D		WASHER M6	20
E		SPRING WASHER M6	20
F		WRENCH K4x60	1

### BEFORE BEGINNING ASSEMBLY:



Read instructions cover to cover



Have two adults on hand for assembly



Do NOT assemble on flooring or carpet. Assemble on a clean non-marring surface (ex: packing foam)



Save all packaging until assembly is completed

## ASSEMBLY STEPS

### STEP 1

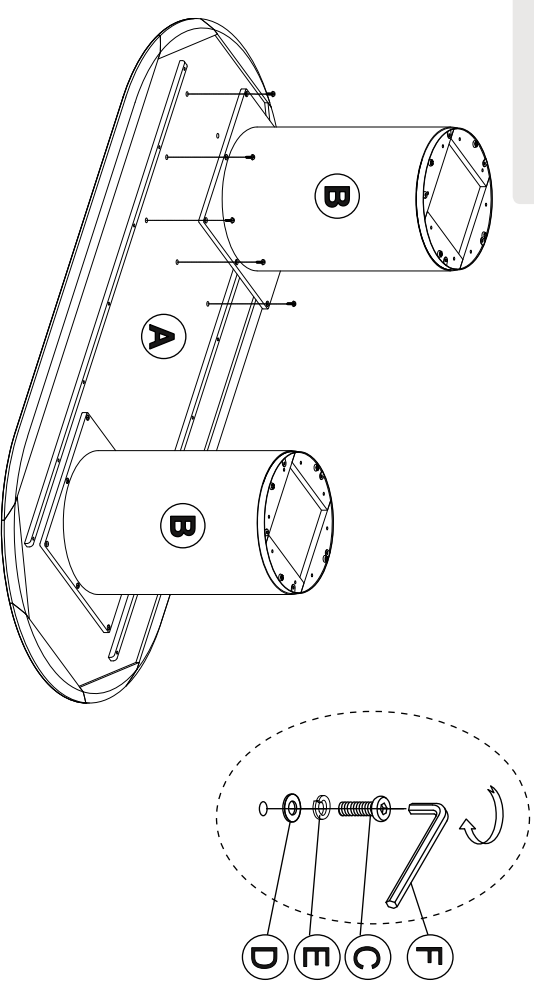

Position the product on its bottom as shown

*Finish*

---

## CARE & MAINTENANCE

---



Do not put hot items directly on furniture surface.



Do not clean furniture with harsh cleansers or polish



Dust and wipe up spills using a clean, non-colored, lint-free cloth.



Stains may be removed with a mild soap solution and a damp cloth.



Do not place furniture under direct sunlight.



Do not place furniture near heating or cooling vents.



Do not write on furniture without a padded barrier to protect the surface.



Do not place furniture outside, for indoor use only.

**"Need a part? Call TOV at 516-888-3355 or  
email [service@tovfurniture.com](mailto:service@tovfurniture.com)"**