



Hailey Bar Stool  
Hailey Counter Stool



# **HAILEY**

---

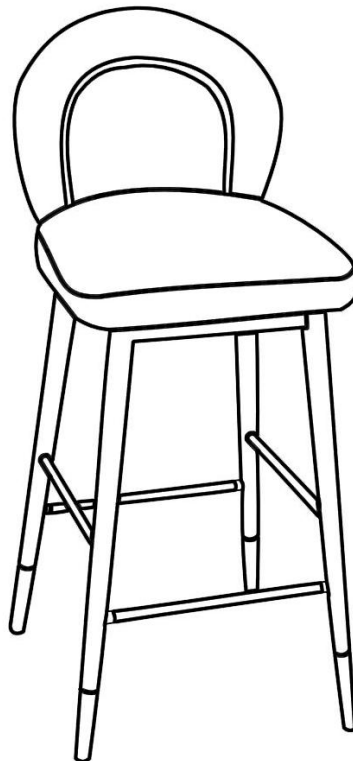

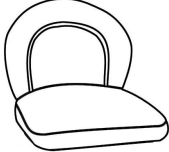

## **ASSEMBLY INSTRUCTIONS**



## PARTS LIST

LABEL	PICTURE	DESCRIPTION	QTY
A		Seat	1
B		Base Frame	1

## HARDWARE LIST

LABEL	PICTURE	DESCRIPTION	QTY
①		Allen Key	1
②		Bolt(M6*40mm)	4
③		Spring Washer	4
④		Washer	4

### BEFORE BEGINNING ASSEMBLY:



*Read instructions cover to cover*



*Have two adults on hand for assembly*



*Do NOT assemble on flooring or carpet. Assemble on a clean non-marring surface (ex : packing foam)*



*Save all packaging until assembly is completed*

Need a part? Call TOV at 516-888-3355 or email [service@tovfurniture.com](mailto:service@tovfurniture.com)

## ASSEMBLY STEPS

### STEP 1

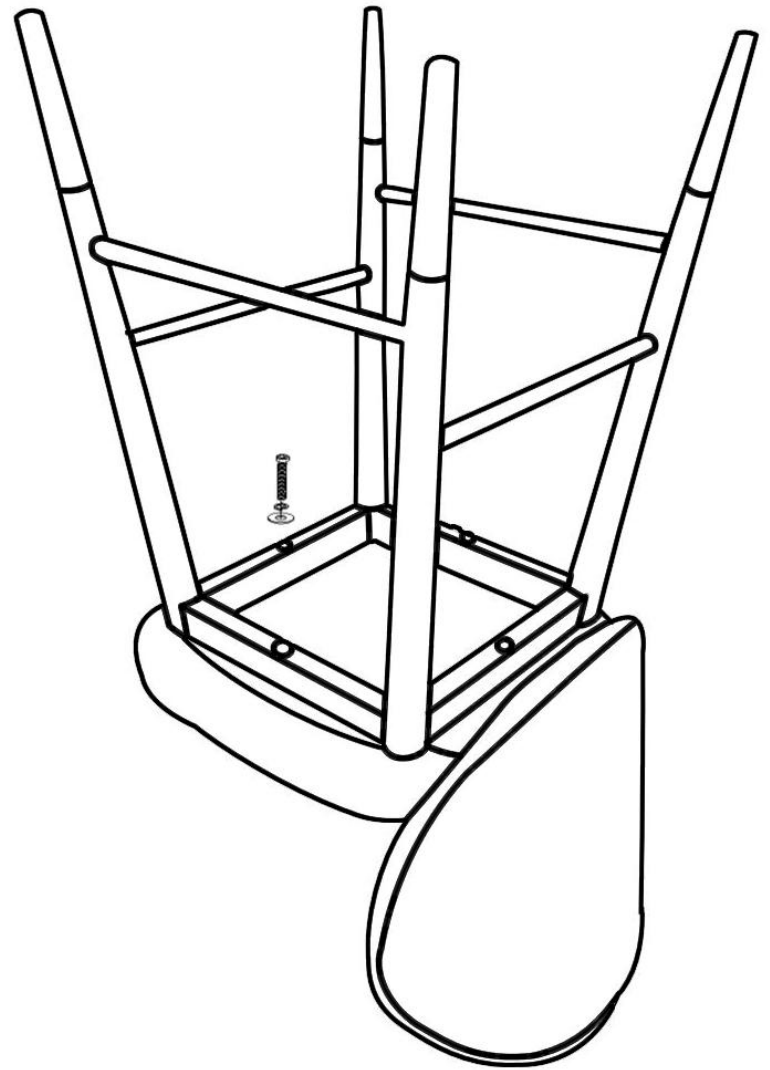
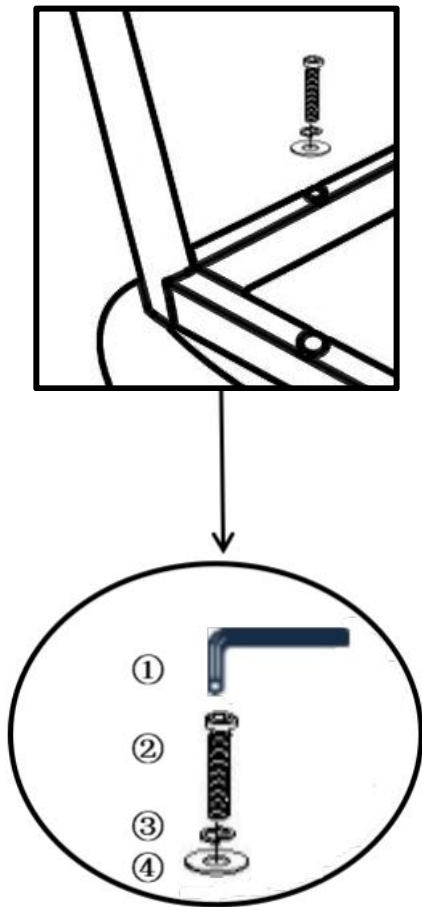

›Place the Base Frame(B) on the Seat(A) as illustrated.

Align and fasten the Base Frame(B) to the Seat(A) using the included Bolts (②), Spring Washers(③) and Washers(④) with the included Allen key(①).

## STEP 2

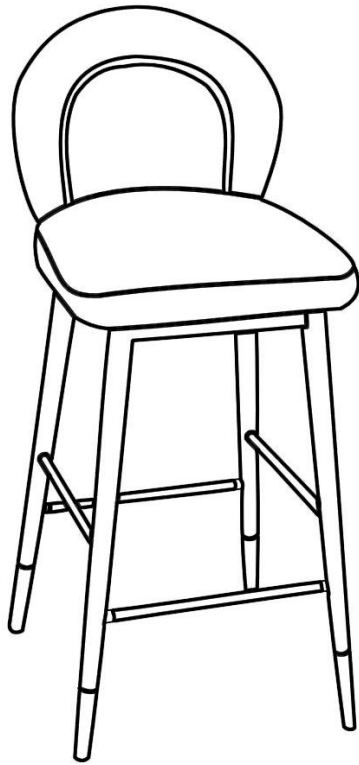

›Set the stool upright and assembly is complete.

---

## CARE & MAINTENANCE

---



Do not put hot items directly on furniture surface.



Do not clean furniture with harsh cleansers or polish.



Dust and pick up spills using a clean, non-colored, lint-free cloth.



Stains may be removed with mild soap solution and a damp cloth.



Do not place furniture under direct sunlight.



Do not place furniture near heating or cooling vents.



Do not write on furniture without a padded barrier to protect the surface.



Do not place furniture outside, for indoor use only.