

Kapri Modular Outdoor  
Armless chair

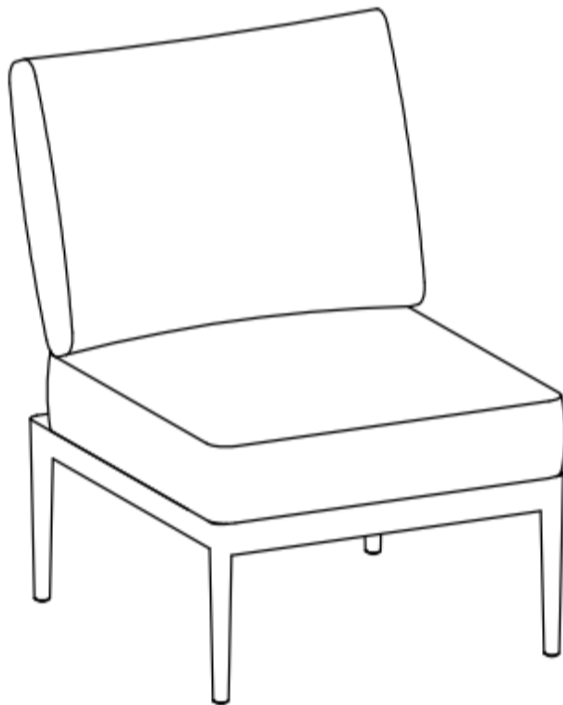



# KAPRI

---



## Assembly Instructions



## PARTS LIST

LABEL	PICTURE	DESCRIPTION	QTY
<b>A</b>		Back Frame	1
<b>B</b>		Seat Frame	1
<b>C</b>		Seat Cushion	1
<b>D</b>		Back Cushion	1

## HARDWARE LIST

LABEL	PICTURE	DESCRIPTION	QTY
<b>E</b>		Bolt M8*20	2
<b>F</b>		Washer	2
<b>G</b>		Allen Key	1

### BEFORE BEGINNING ASSEMBLY:



*Read instructions cover to cover*



*Have two adults on hand for assembly*



*Do NOT assemble on flooring or carpet. Assemble on a clean non-marring surface (ex: packing foam)*



*Save all packaging until assembly is completed*

*Need a part? Call TOV at 516-888-3355 or email [service@tovfurniture.com](mailto:service@tovfurniture.com)*

## ASSEMBLY STEPS

### STEP 1

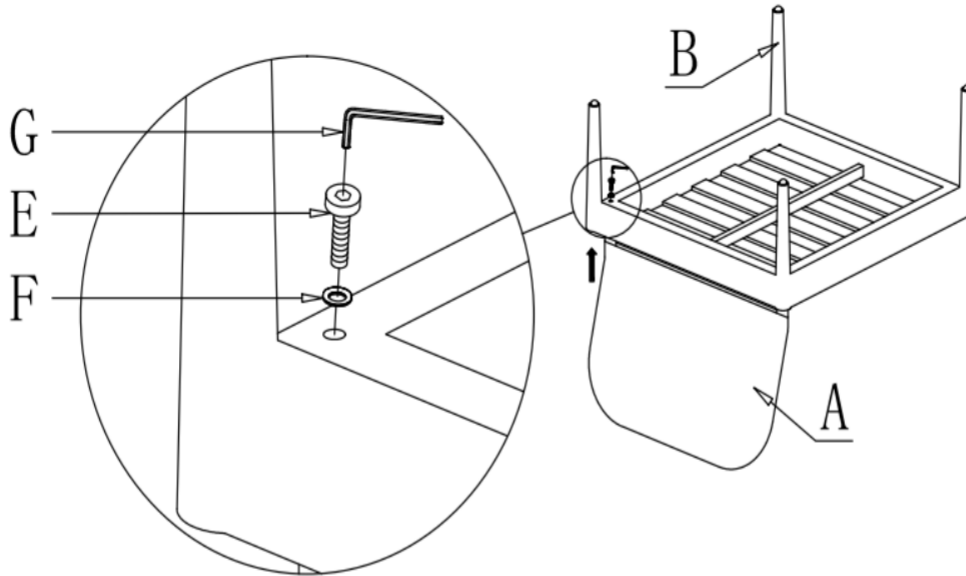

- > Attach back frame A to seat frame B by using bolt E, washer F and allen key G.

### STEP 2

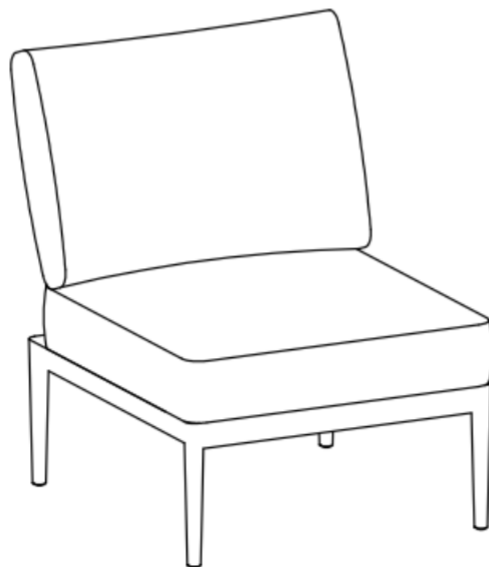

- > Put seat cushion C, back cushion D on seat frame, now it is ready for using.

## CARE & MAINTENANCE



**Do not put hot items directly on furniture surface.**



**Do not clean furniture with harsh cleansers or polish.**



**Dust and wipe up spills using a clean, non-colored, lint-free cloth.**



**Stains may be removed with mild soap solution and a damp cloth**



**Do not place furniture under direct sunlight.**



**Do not place furniture near heating or cooling vents.**



**Do not write on furniture without a padded barrier to protect the surface.**