



Celine Bed  
King/Queen Size





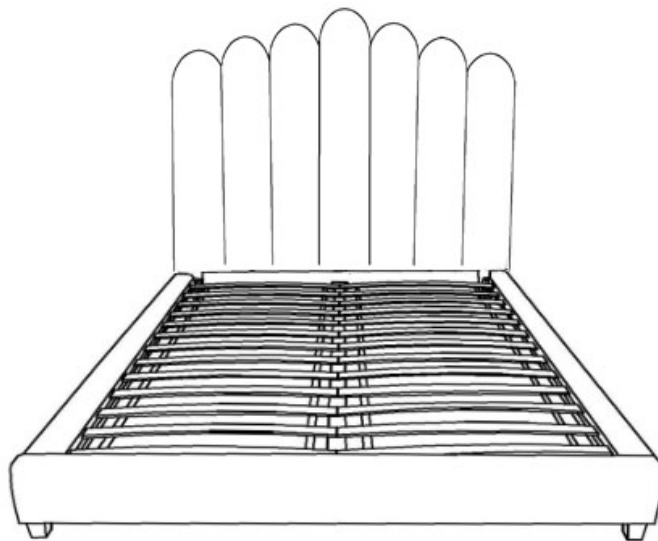

# CELINE

---

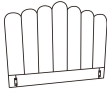

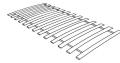

## ASSEMBLY INSTRUCTIONS



## PARTS LIST

LABEL	PICTURE	DESCRIPTION	QTY
<b>A</b>		<b>HEADBOARD</b>	<b>1</b>
<b>B</b>		<b>RAIL</b>	<b>2</b>
<b>C</b>		<b>FOOTBOARD</b>	<b>1</b>
<b>D</b>		<b>SLAT</b>	<b>2</b>
<b>E</b>		Support Bar	<b>1</b>
<b>F</b>		Slat Support Leg	<b>3</b>
<b>G</b>		BED LEG	<b>4</b>

## HARDWARE

LABEL	PICTURE	DESCRIPTION	QTY
<b>H</b>		Cross Slat Bolt M8*30MM	<b>12</b>
<b>I</b>		<b>Spring Washer</b>	<b>4</b>
<b>J</b>		<b>Metal Gasket</b>	<b>4</b>
<b>K</b>		Slat Support Leg Bolt M8*45MM	<b>3</b>
<b>L</b>		<b>Wrench</b>	<b>1</b>

## BEFORE BEGINNING ASSEMBLY:



Read instructions cover to cover



Have two adults on hand for assembly



Do NOT assemble on flooring or carpet. Assemble on a clean non-marring surface (ex: packing foam)



Save all packaging until assembly is completed

Need a part? Call TOV at 516-888-3355 or email [service@tovfurniture.com](mailto:service@tovfurniture.com)

## ASSEMBLY STEPS

### STEP 1

Attach the bed legs(G) and ensure all legs are securely attached

Attach the side rails to the headboard and footboard using the pre attached hardware. Once the bed is assembled tighten all bolts securely.

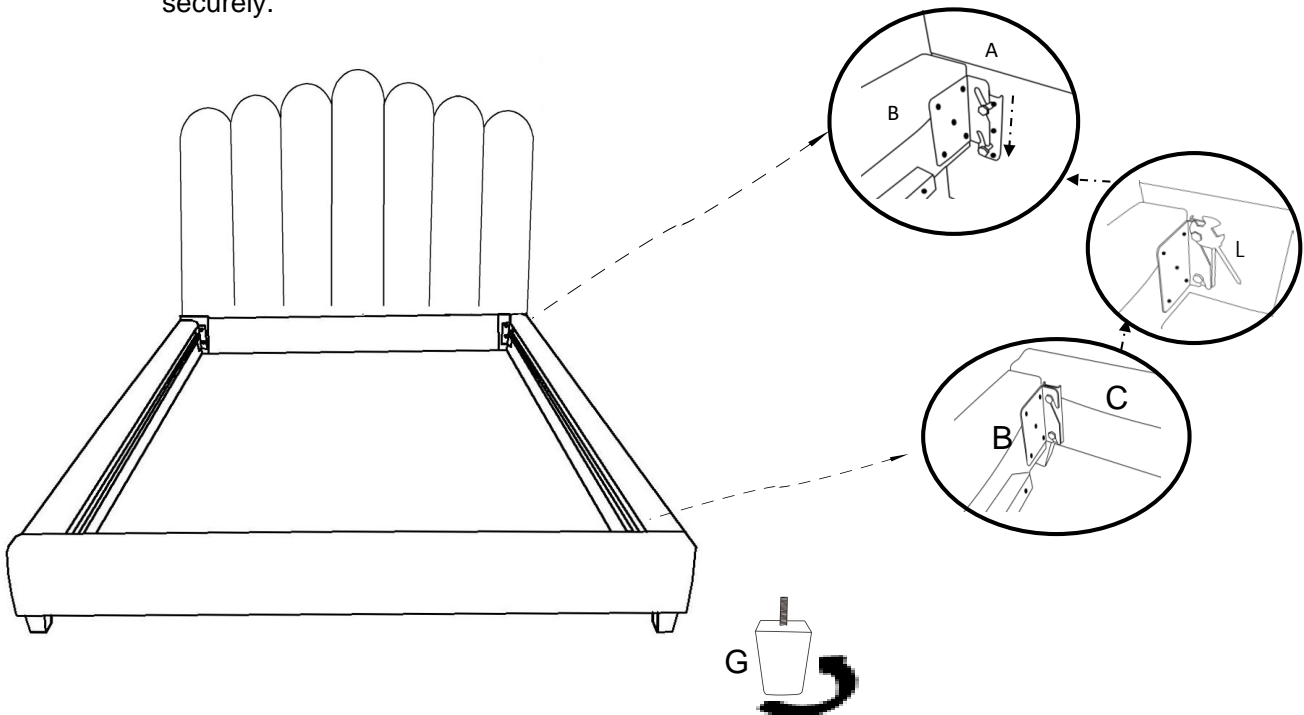

# ASSEMBLY STEPS

Attach the 3 support legs to the support bar and ensure all legs are securely attached.

**STEP 2** Connect the support bar to the HB and FB, secure them using the Cross Slat Bolt.

Position the slat frames inside the bed and secure them using the slat bolts. Use the included wrench to tighten them.

The slat support legs have adjustable glides and can be adjusted to level the slat frame as needed.

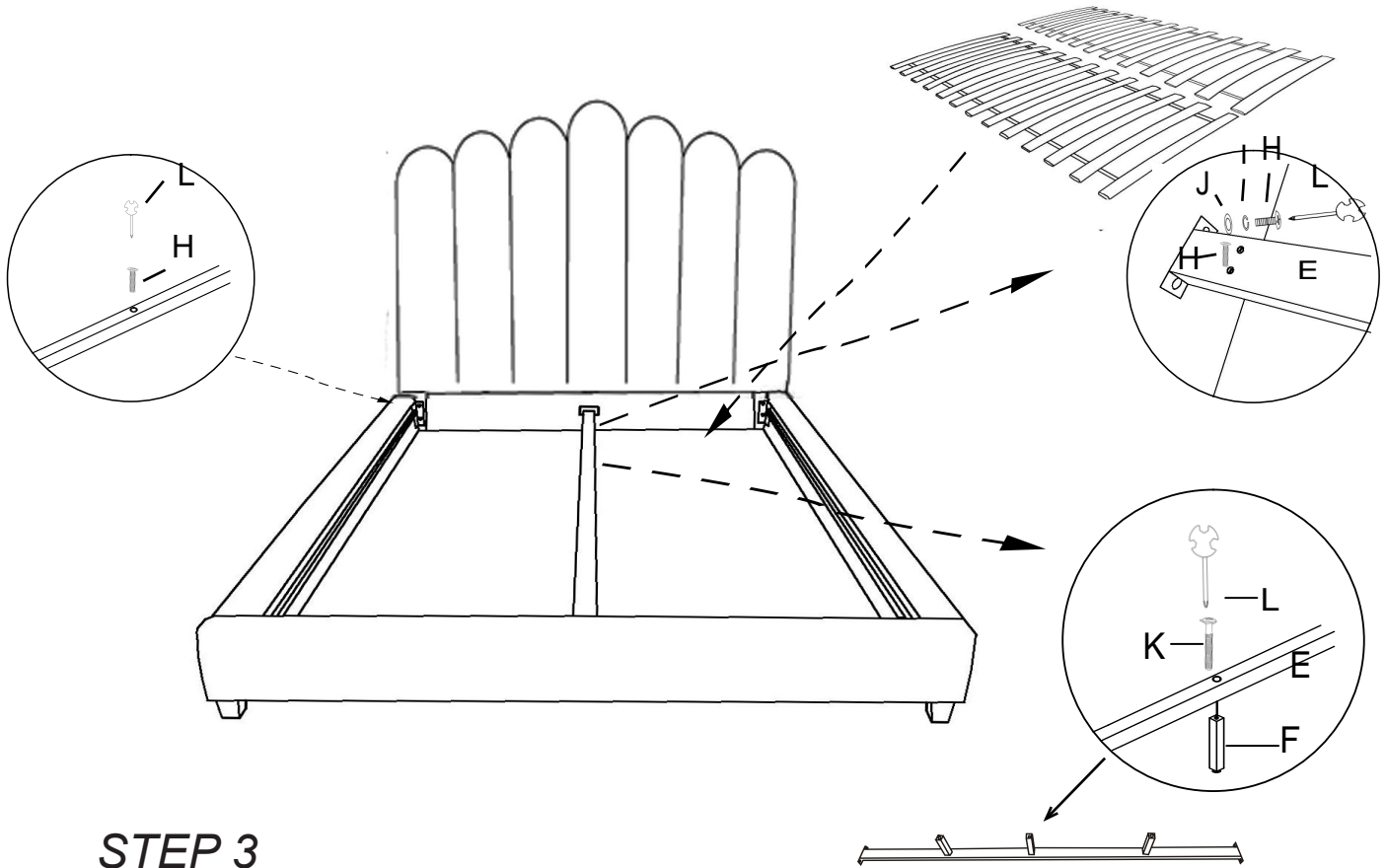

**STEP 3**

Assembly is complete.

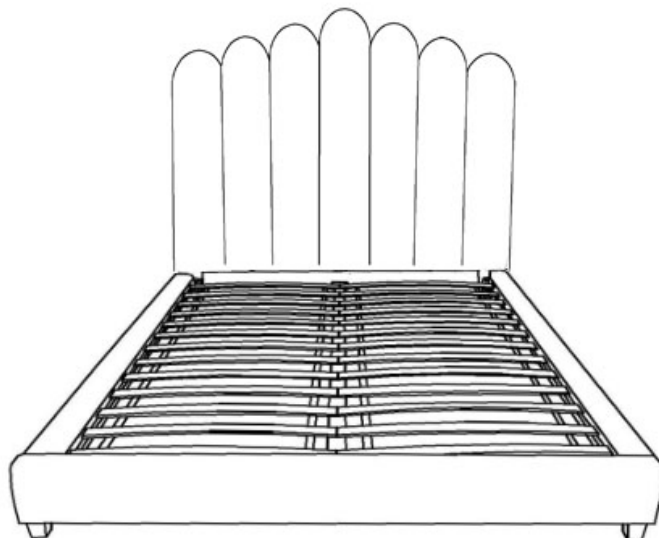

## **CARE & MAINTENANCE**



**Do not put hot items directly on furniture surface.**



**Do not clean furniture with harsh cleansers or polish.**



**Dust and pick up spills using a clean, non-colored, lint-free cloth.**



**Stains may be removed with a mild soap solution and a damp cloth.**



**Do not place furniture under direct sunlight.**



**Do not place furniture near heating or cooling vents.**



**Do not write on furniture without a padded barrier to protect the surface.**



**Do not place furniture outside, for indoor use only.**