

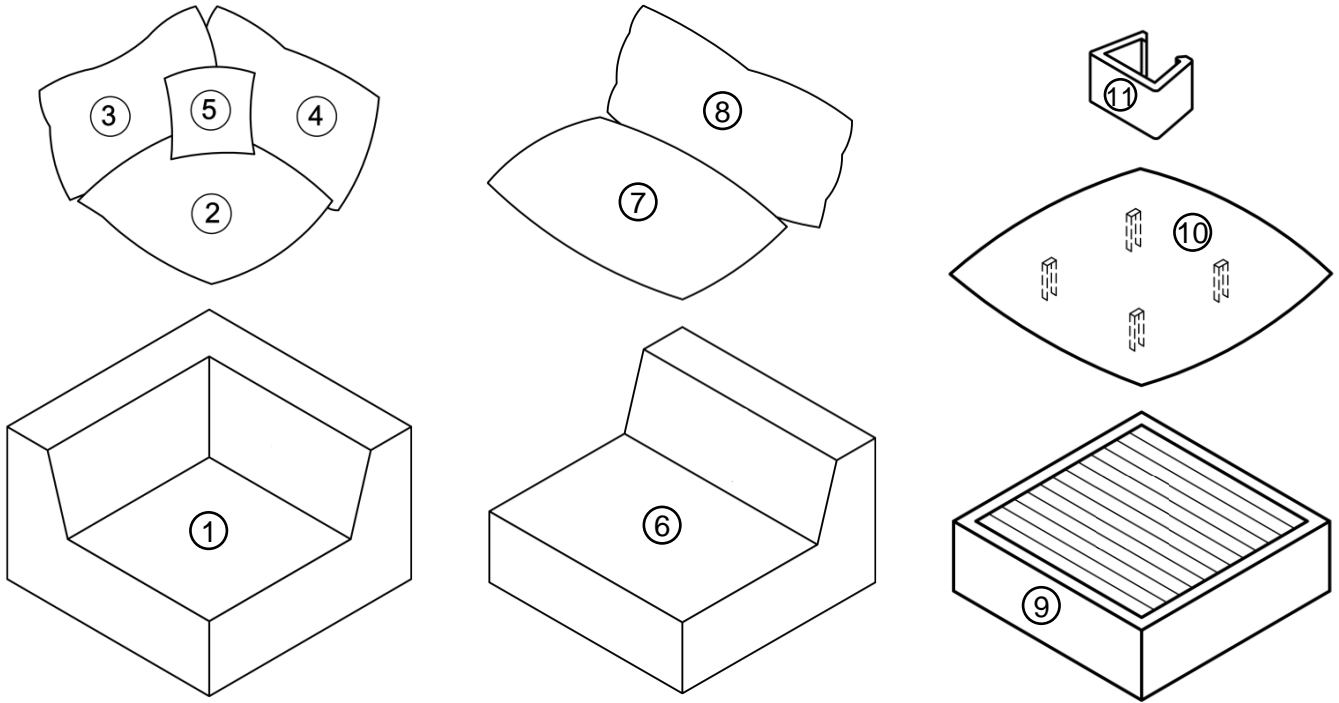

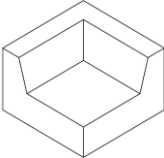

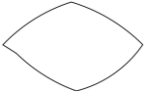

Cali Ci hXccf' Modular Sectional **ASSEMBLY INSTRUCTIONS**

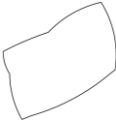

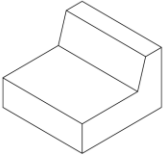
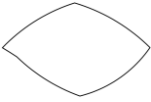

COMPONENTS LISTED for Corner Seat

LABEL	PICTURE	DESCRIPTION	QTY
1		Corner Seat Body	1
2		Seat Cushion	1
3		Small Back Cushion	1
4		Large Back Cushion	1
5		Pillow	1
11		Connector	2

**COMPONENTS LISTED for
Armless Chair**

LABEL	PICTURE	DESCRIPTION	QTY
6		Armless Chair Body	1
7		Seat Cushion	1
8		Back Cushion	1
11		Connector	2

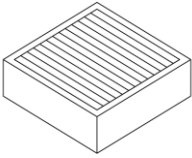
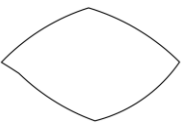
**COMPONENTS LISTED for
Ottoman**

LABEL	PICTURE	DESCRIPTION	QTY
9		Ottoman Body	1
10		Seat Cushion	1
11		Connector	2

BEFORE BEGINNING ASSEMBLY:



Read instructions cover to cover



Have two adults on hand for assembly



Do NOT assemble on flooring or carpet. Assemble on a clean non-marring surface (ex: packing foam)



Save all packaging until assembly is completed

ASSEMBLY STEPS

STEP 1

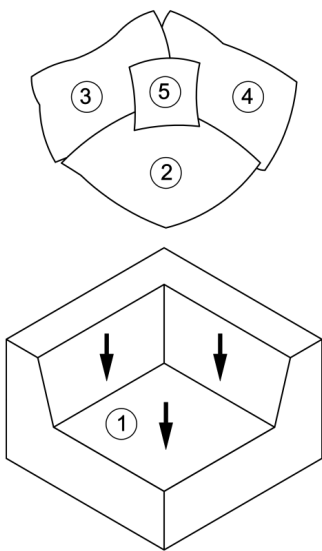

CORNER SEAT

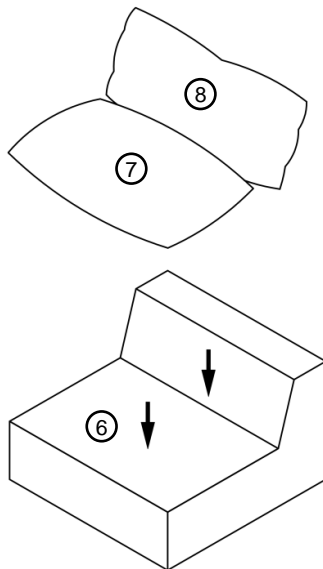

ARMLESS CHAIR

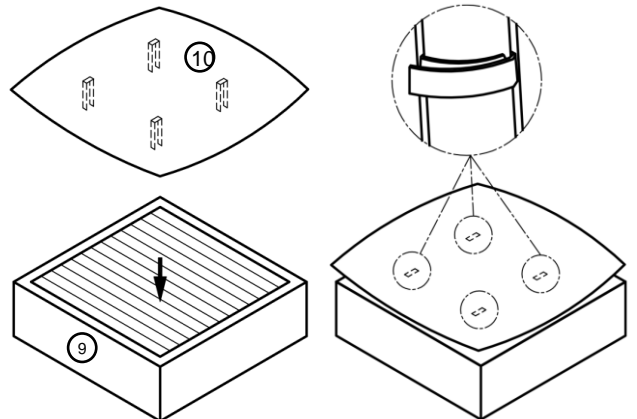

OTTOMAN

STEP 2

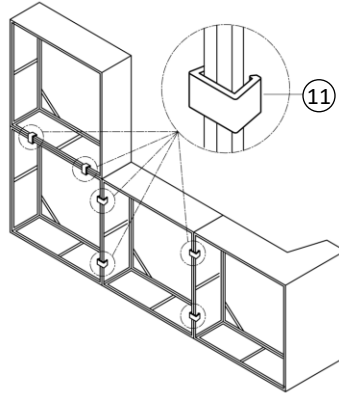

Option A:

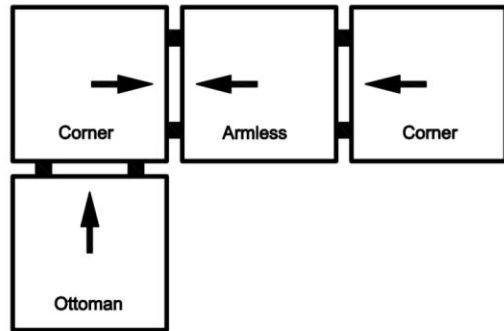
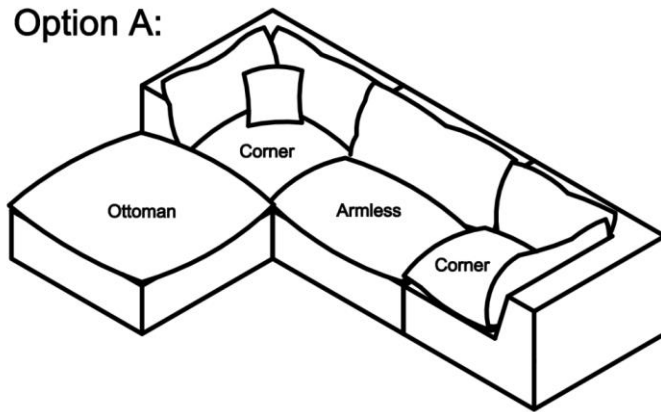

Option B:

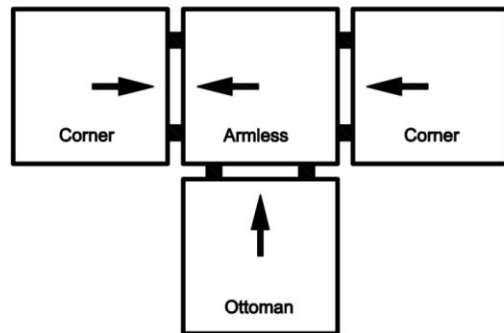
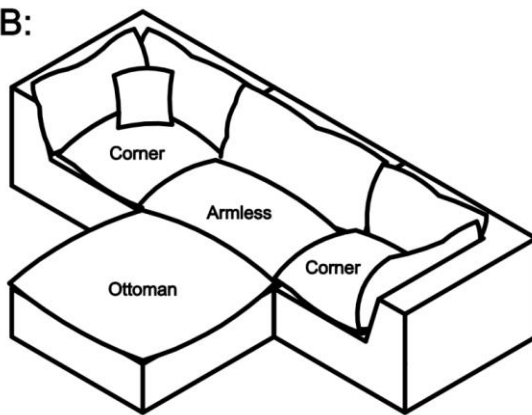

Option C:

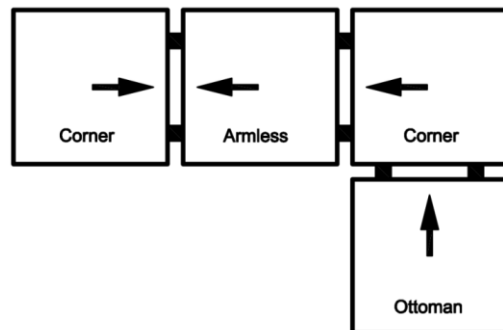
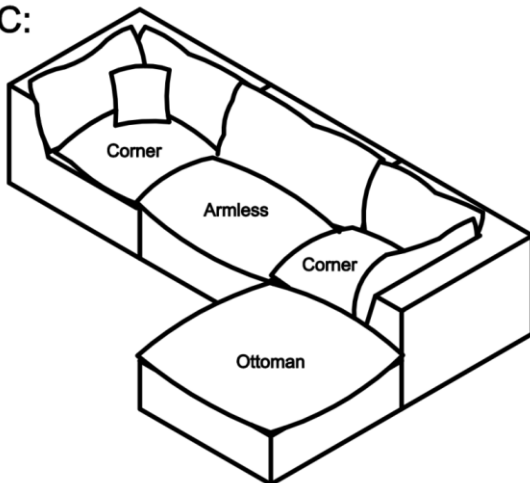

CARE & MAINTENANCE



Do not put hot items directly on furniture surface.



Do not clean furniture with harsh cleansers or polish



Dust and wipe up spills using a clean, non-colored, lint-free cloth.



Stains may be removed with mild soap solution and a damp cloth.



Do not place furniture under direct sunlight.



Do not place furniture near heating or cooling vents.



Do not write on furniture without a padded barrier to protect the surface.



Safe for outdoor, recommend under roof.