

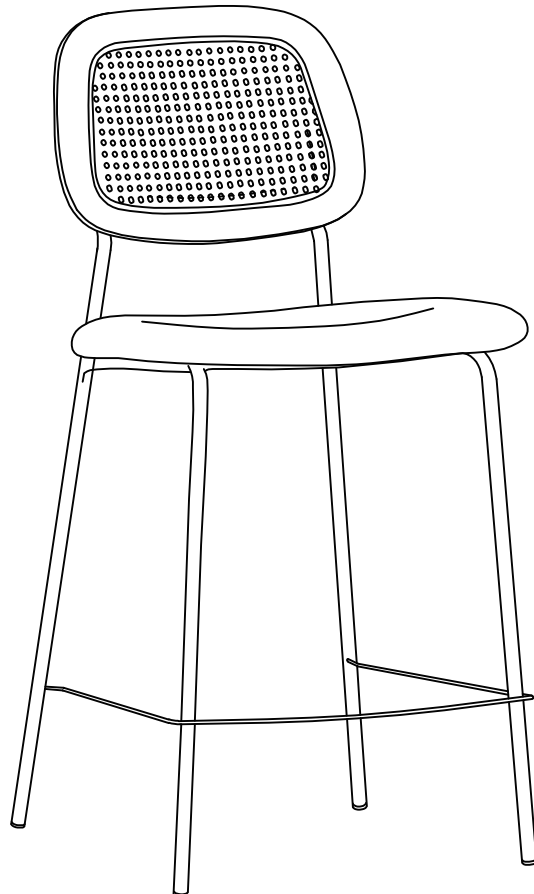

Anais Counter Stool

ANAIS



ASSEMBLY INSTRUCTIONS



PARTS LIST

LABEL	PICTURE	DESCRIPTION	QTY
①		Backrest	1
②		Chair Leg	1

HARDWARE

LABEL	PICTURE	DESCRIPTION	QTY
A		Bolt (M6x30mm)	4
B		Allen Key	1

BEFORE BEGINNING ASSEMBLY:



Read instructions cover to cover



Have two adults on hand for assembly



Do NOT assemble on flooring or carpet. Assemble on a clean non-marring surface (ex: packing foam)



Save all packaging until assembly is completed

Need a part? Call TOV at 516-888-3355 or email service@tovfurniture.com

ASSEMBLY STEPS

STEP 1

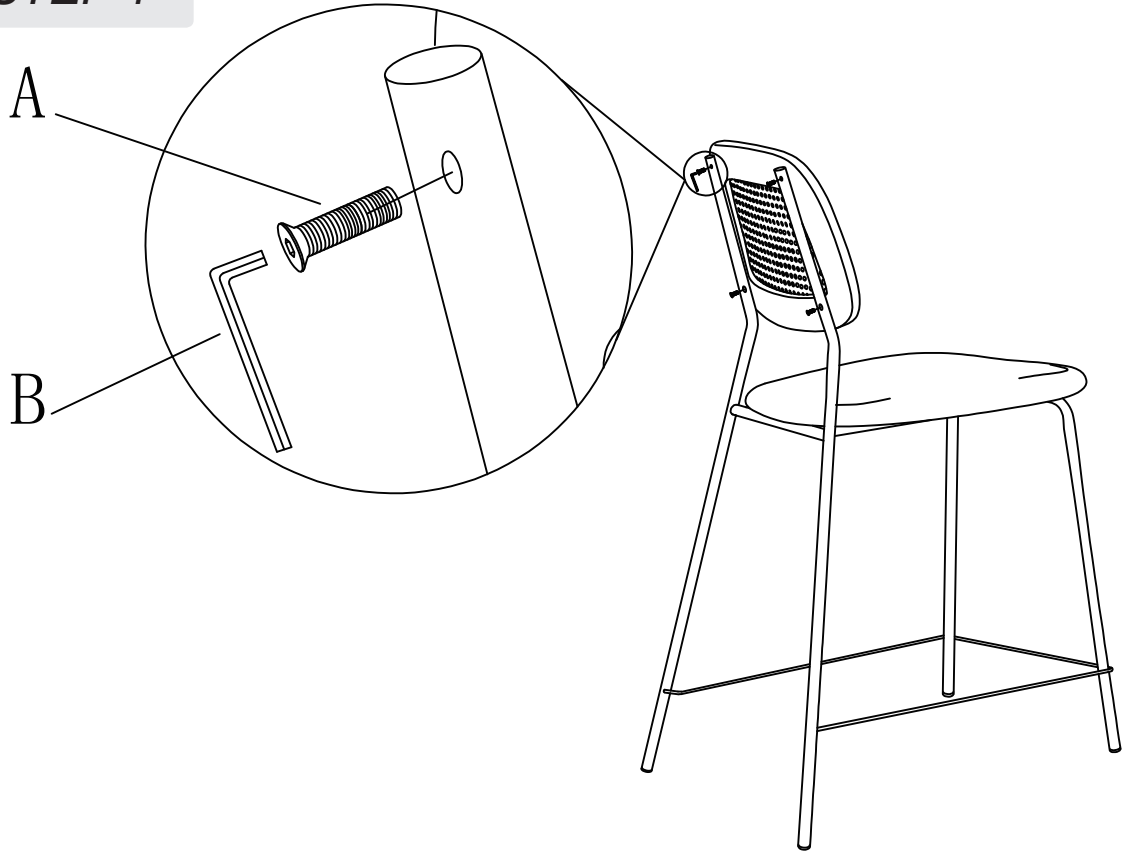

STEP 1

Set the chair upright and ensure the legs are level. Once done, finish tightening the screws and the assembly is complete.

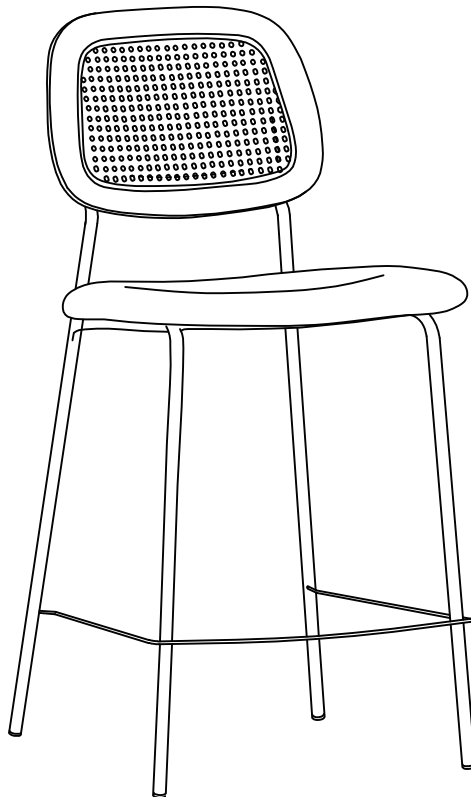

CARE & MAINTENANCE



Do not put hot items directly on furniture surface.



Do not clean furniture with harsh cleansers or polish.



Dust and wipe spills using a clean, non-colored, lint-free cloth.



Stains may be removed with mild soap solution and a damp cloth.



Do not place furniture under direct sunlight.



Do not place furniture near heating or cooling vents.



Do not write on furniture without a padded barrier to protect the surface.



Do not place furniture outside, for indoor use only.