

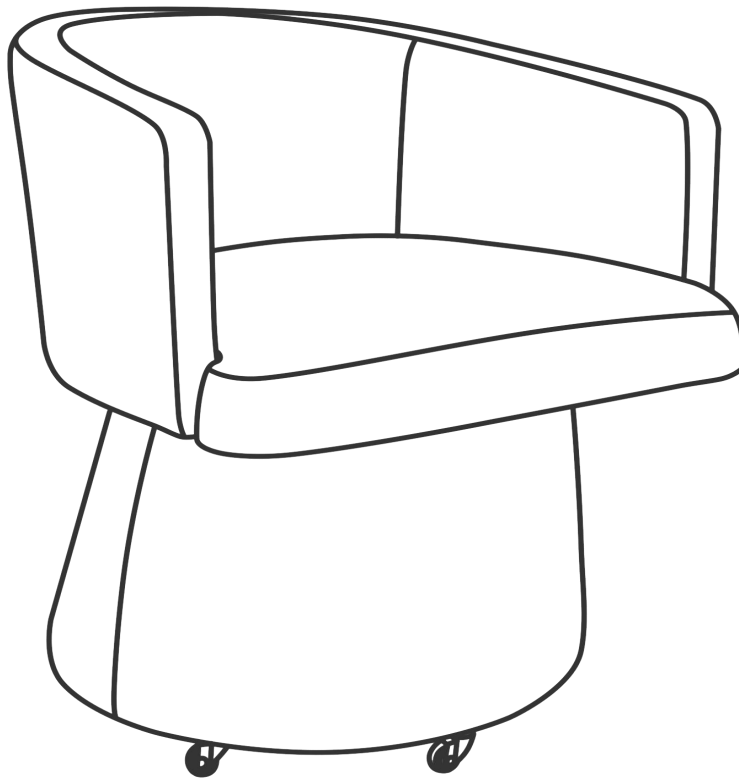

Kristen Rolling Desk Chair

KRISTEN



ASSEMBLY INSTRUCTIONS

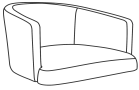
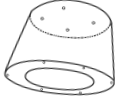

PARTS LIST

LABEL	PICTURE	DESCRIPTION	QTY
A		Seat	1
B		Base	1
C		Glider	6

HARDWARE

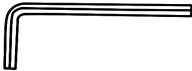
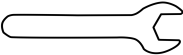
LABEL	PICTURE	DESCRIPTION	QTY
D		Bolt(M8*40)	4
E		Spring Washer	4
F		Washer	4
G		Allen Key	1
H		Wrench	1

BEFORE BEGINNING ASSEMBLY:



Read instructions cover to cover



Have two adults on hand for assembly



DO NOT assemble on flooring or carpet. Assemble on a clean non-marring surface(ex: packing foam)



Save all packaging until assembly is completed

Need a part? Call TOV at 516-888-3355 or email service@tovfurniture.com

ASSEMBLY STEPS

STEP 1

Please open the zipper underneath chair and there are the wheels and Hardware pack

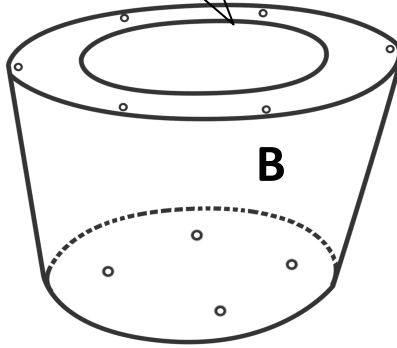
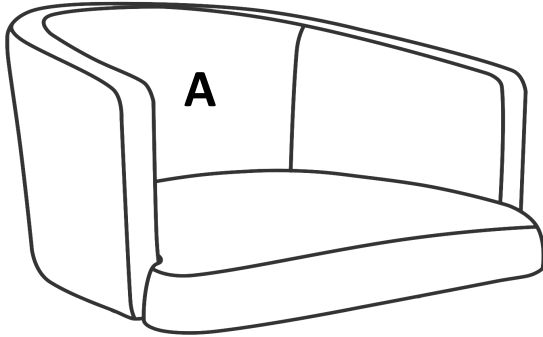
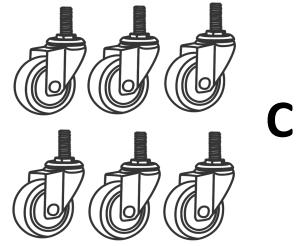

› Position the product bottom-side up and screw the base and wheels into the pre-drilled holes

STEP 2

STEP 3

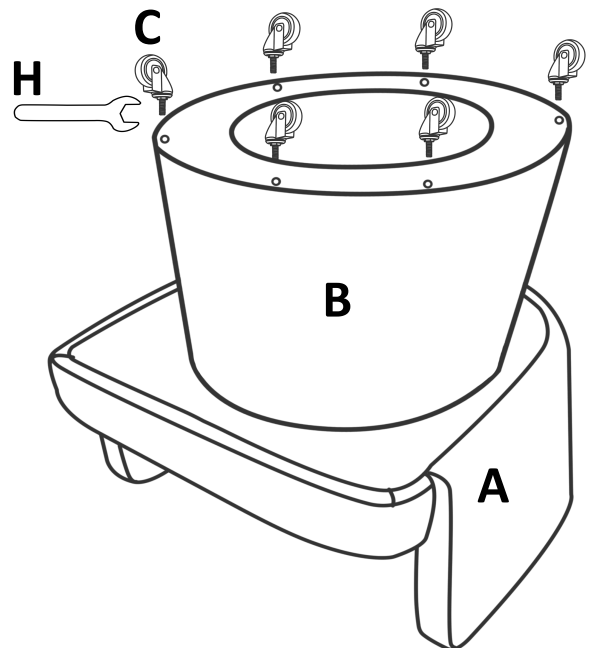
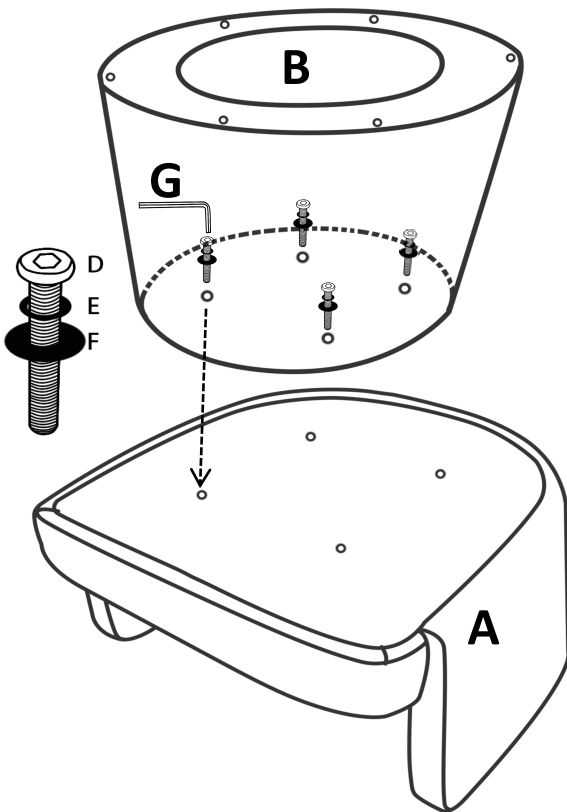

› Tighten the 4 bolts with allen key(G)

› Tighten the 6 Gliders with wrench(H)

STEP 4

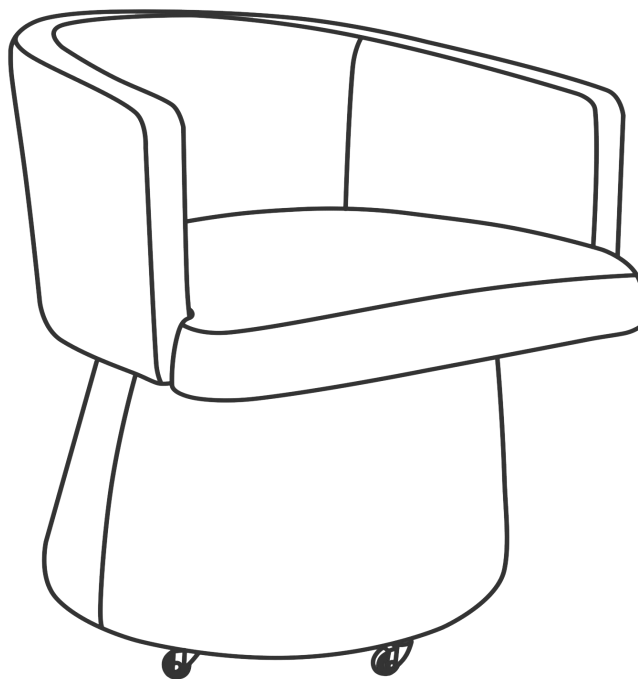

› Assembly is completed

CARE & MAINTENANCE



Do not put hot items directly on furniture surface



Do not clean furniture with harsh cleansers or polish.



Dust and pick up spills using a clean, non-colored, lint-free cloth.



Stains may be removed with a mild soap solution and a damp cloth.



Do not place furniture under direct sunlight.



Do not place furniture near heating or cooling vents.



Do not write on furniture without a padded barrier to protect the surface.



Do not place furniture outside, for indoor use only.