

AKIBA DINING TABLE

AKIBA



ASSEMBLY INSTRUCTIONS

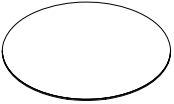
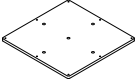
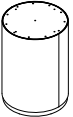

PARTS LIST

Label	Picture	Description	Qty
A		Top	1
B		Support panel	1
C		Leg	1

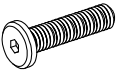
HARDWARE

Label	Picture	Description	Qty
D		Bolt M6x25	13
E		Washer M6	13
F		Wrench K4x60	2

BEFORE BEGINNING ASSEMBLY:



Read instructions cover to cover



Have two adults on hand for assembly



Do NOT assemble on flooring or carpet. Assemble on a clean non-marring surface (ex: packing foam)



Save all packaging until assembly is completed

ASSEMBLY STEPS

Step 1

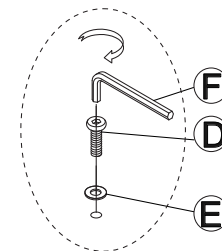
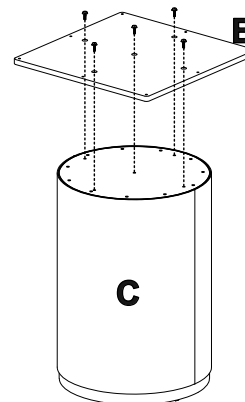

Step 2

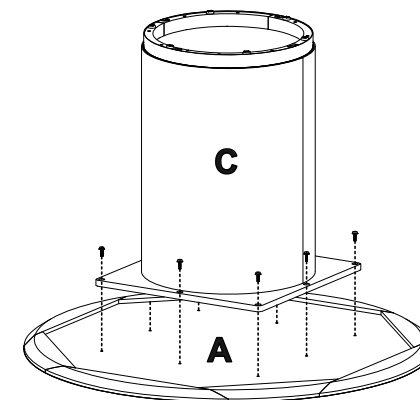

Position the product with care and secure the legs as shown

Finish

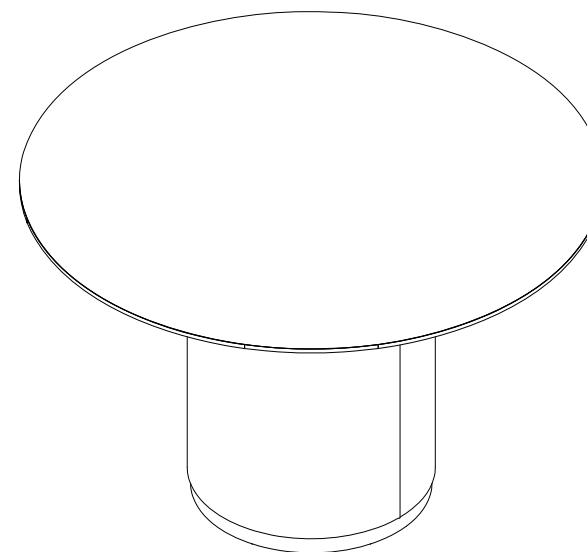

CARE & MAINTENANCE



Do not put hot items directly on furniture surface.



Do not clean furniture with harsh cleansers or polish



Dust and wipe up spills using a clean, non-colored, lint-free cloth.



Stains may be removed with a mild soap solution and a damp cloth.



Do not place furniture under direct sunlight.



Do not place furniture near heating or cooling vents.



Do not write on furniture without a padded barrier to protect the surface.



Do not place furniture outside, for indoor use only.

**"Need a part? Call TOV at 516-888-3355 or
email service@tovfurniture.com"**