

T O V

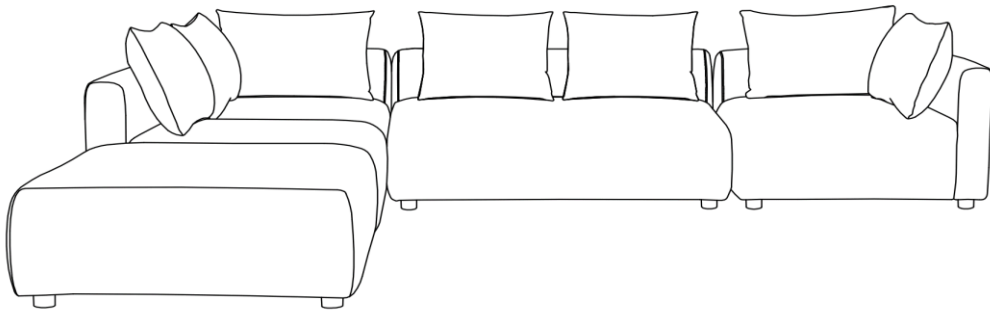

Hangover Modular Seating

DON'T BE BORING.

Hardware and Components



Sectionals Body

A X 1pc



Plastic Legs

B X 4pcs
(ϕ 60mm X H30mm)

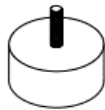

Wood Legs

C X 4pcs
(ϕ 60mm X H50mm)



Plastic Washer

D X 4pcs (ϕ 48mm)

Step 1

A. Position the Sectionals body with its bottom facing up. (part A)

B. Open the zippered compartment to remove the 4 legs and 4 Plastic Washers. (parts C and D)

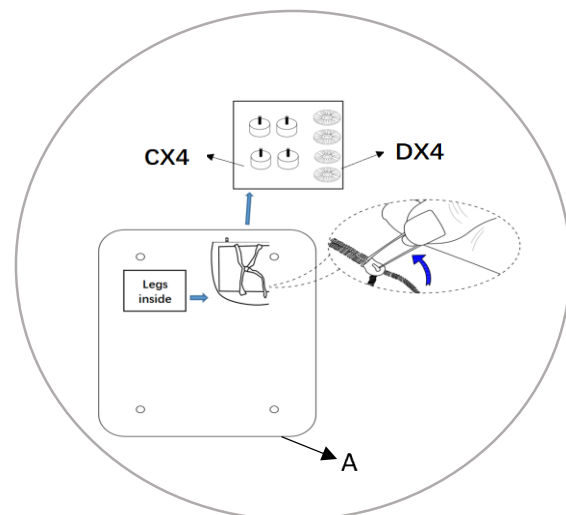

Step 2

C. You can move away the plastic legs B and throw away.
(The plastic legs are just for protecting the carton)

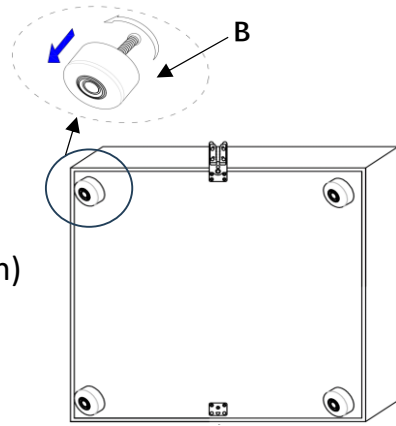

Step 3

D. Repeat 4X, for all 4 wooden legs and 4 plastic washers.

E. Install the wooden legs with plastic washers together by threading them into the pre-drilled holes as illustrated.

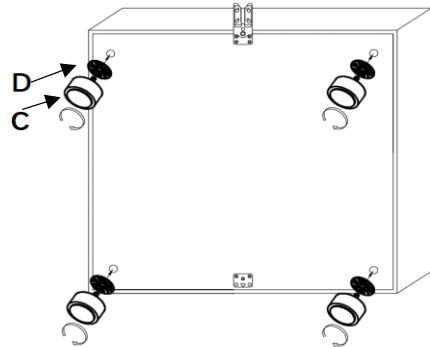

Step 4

E. Connect all sectionals together

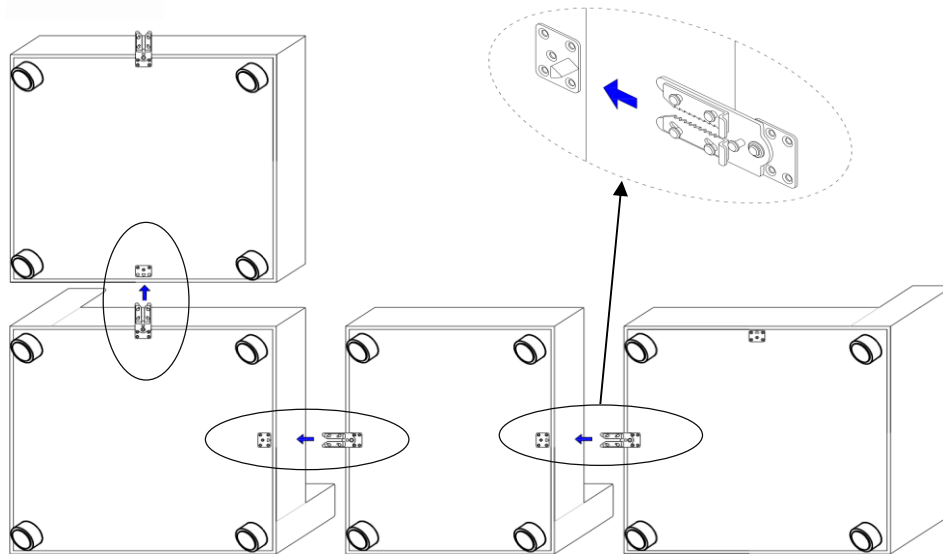

Stuck?
Contact our team @ 516-888-3355

Scan for product care!



TOV



Follow us!

Show your new purchase some love by tagging it on our Instagram!

 @tovfurniture

 516-888-3355

 hello@tovfurniture.com

 www.tovfurniture.com

If the future is female—your furniture should be, too. No mahogany in sight. Sexy settees shaped like lips. Price points for any budget. At TOV, we do things differently.