

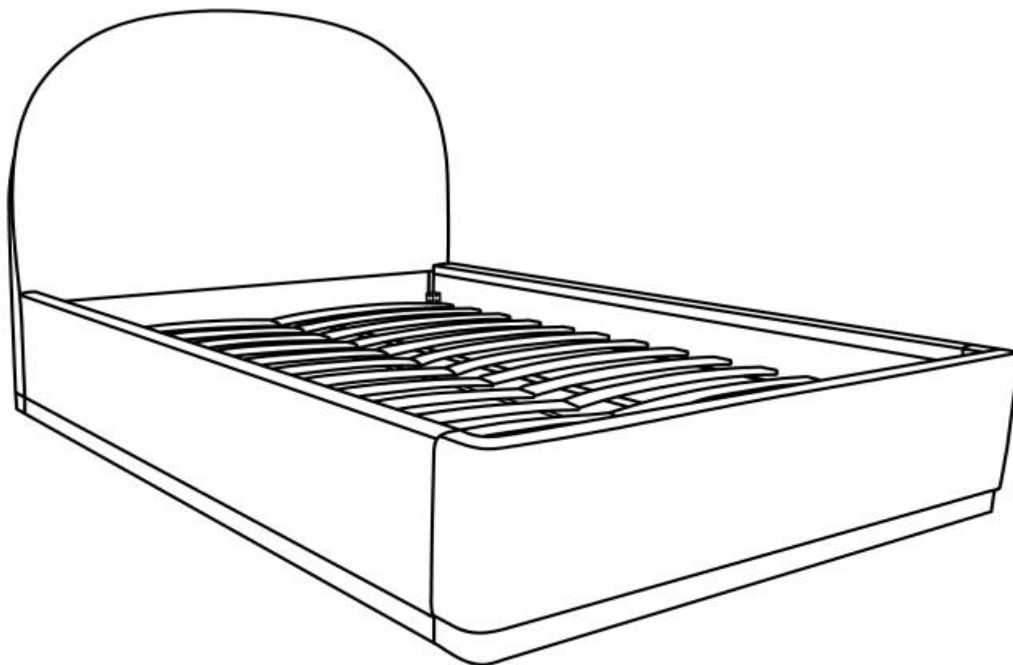







Marlow Bed-King/Queen

Marlow



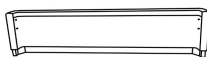

ASSEMBLY INSTRUCTIONS



PARTS LIST

LABLE	PICTURE	DESCRIPTION	QTY
A		Headboard	1
B		Side Rail	2
C		Footboard	1
D		Slats	2
E		Support Rail	1
F		Support Legs	3

HARDWARE

LABLE	PICTURE	DESCRIPTION	QTY
H		Wrench	1
I		Spring Washer	4
J		Metal Gasket	4
K		Screw (M8*4.5)	3
L		Screw (M8*3)	12

BEFORE BEGINNING ASSEMBLY:



Read instructions cover to cover



Have two adults on hand for assembly



DO NOT assemble on flooring or carpet. Assemble on a clean non-marring surface(ex: packing foam)



Save all packaging until assembly is completed

ASSEMBLY STEPS

STEP 1

Attach 4 L screws and 3 K screws to the support rail as illustrated below.

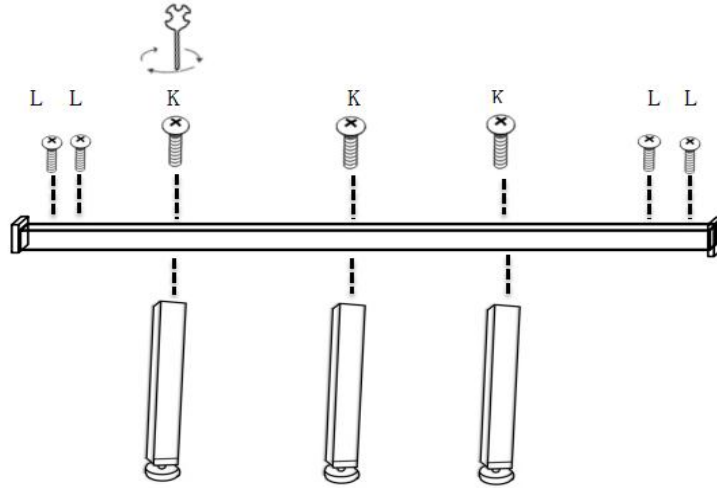

ASSEMBLY STEPS

STEP 2

Attach the 4 L screws to the side boards as illustrated below.

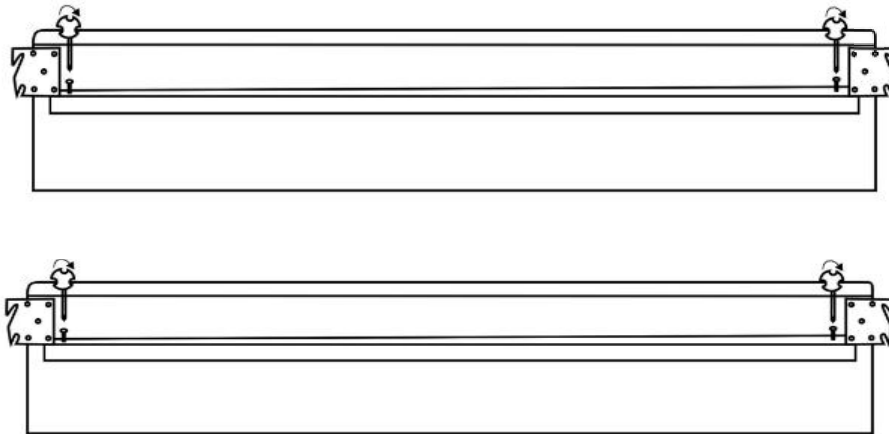

ASSEMBLY STEPS

STEP 3

Connect the headboard side boards and footboard with the wrench (H) as illustrated below.

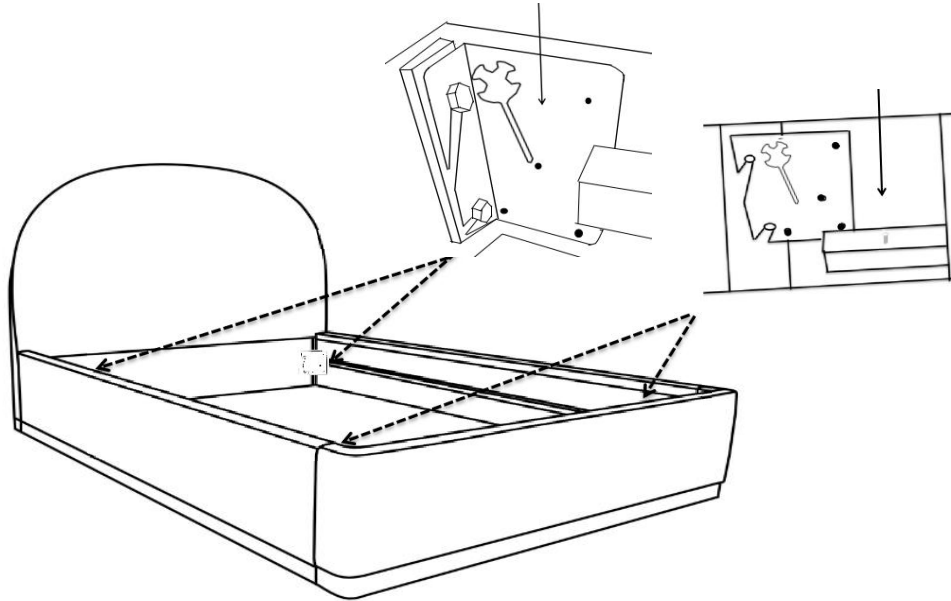

ASSEMBLY STEPS

STEP 4

Attach 4 L screws to the support rail as illustrated below.

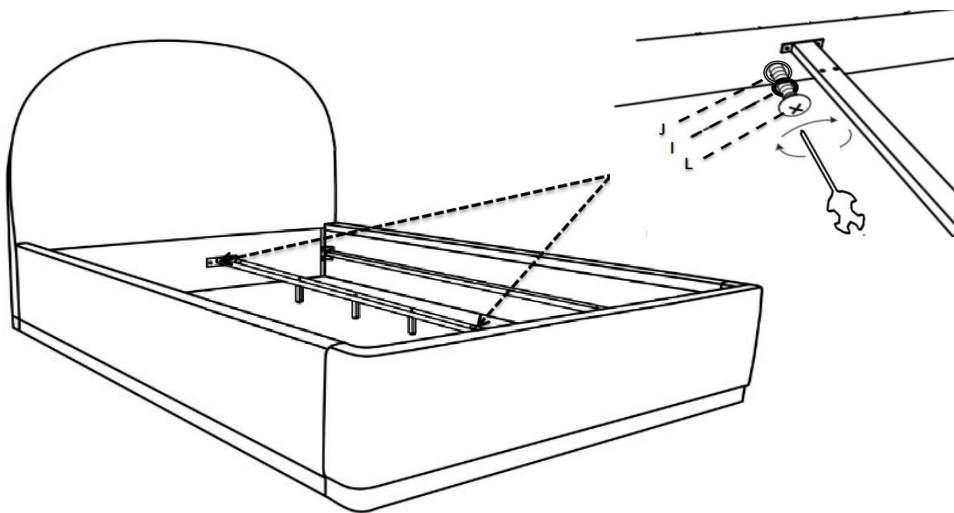

ASSEMBLY STEPS

STEP 5

Place the slats on the support rail as illustrated below.

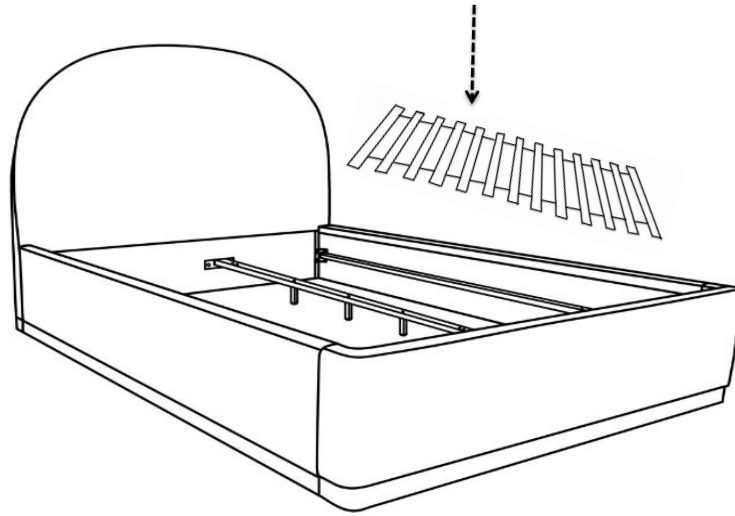

ASSEMBLY STEPS

STEP 6

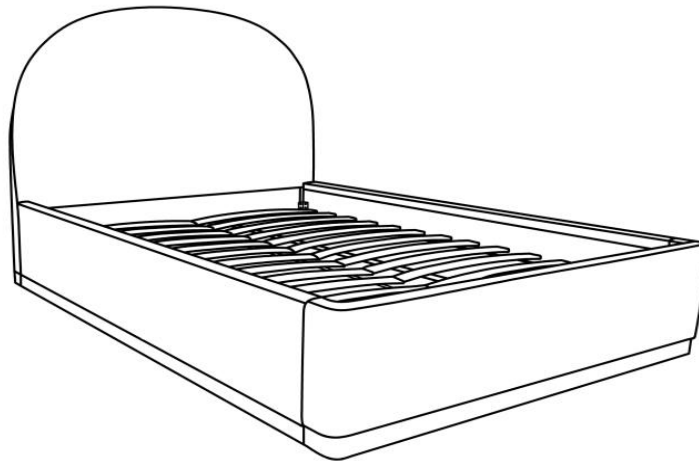

CARE & MAINTENANCE



Do not put hot items directly on furniture surface



Do not clean furniture with harsh cleansers or polish.



Dust and pick up spills using a clean, non-colored, lint-free cloth.



Stains may be removed with a mild soap solution and a damp cloth.



Do not place furniture under direct sunlight.



Do not place furniture near heating or cooling vents.



Do not write on furniture without a padded barrier to protect the surface.



Do not place furniture outside, for indoor use only.