

TOV



Follow us!

Show your new purchase some love by tagging it on our Instagram!

 @tovfurniture

 516-888-3355

 hello@tovfurniture.com

 www.tovfurniture.com

If the future is female—your furniture should be, too. No mahogany in sight. Sexy settees shaped like lips. Price points for any budget. At TOV, we do things differently.

TOV

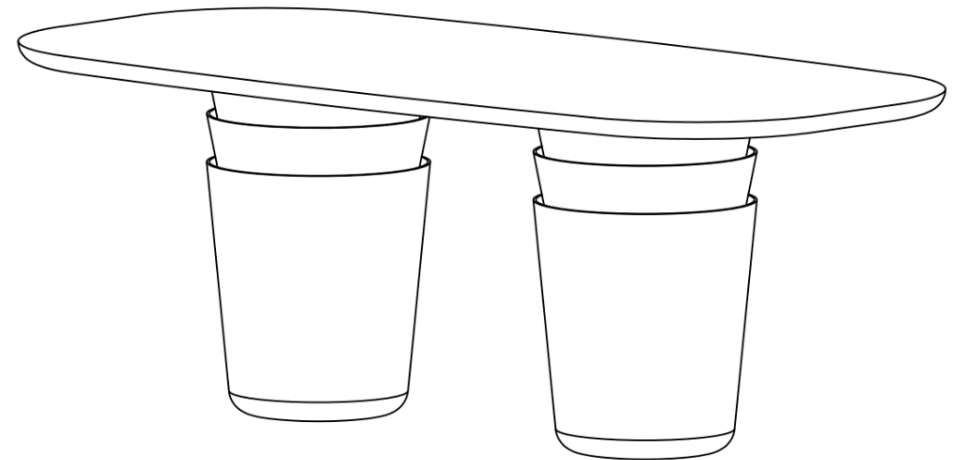

MARGOT

DON'T BE BORING.

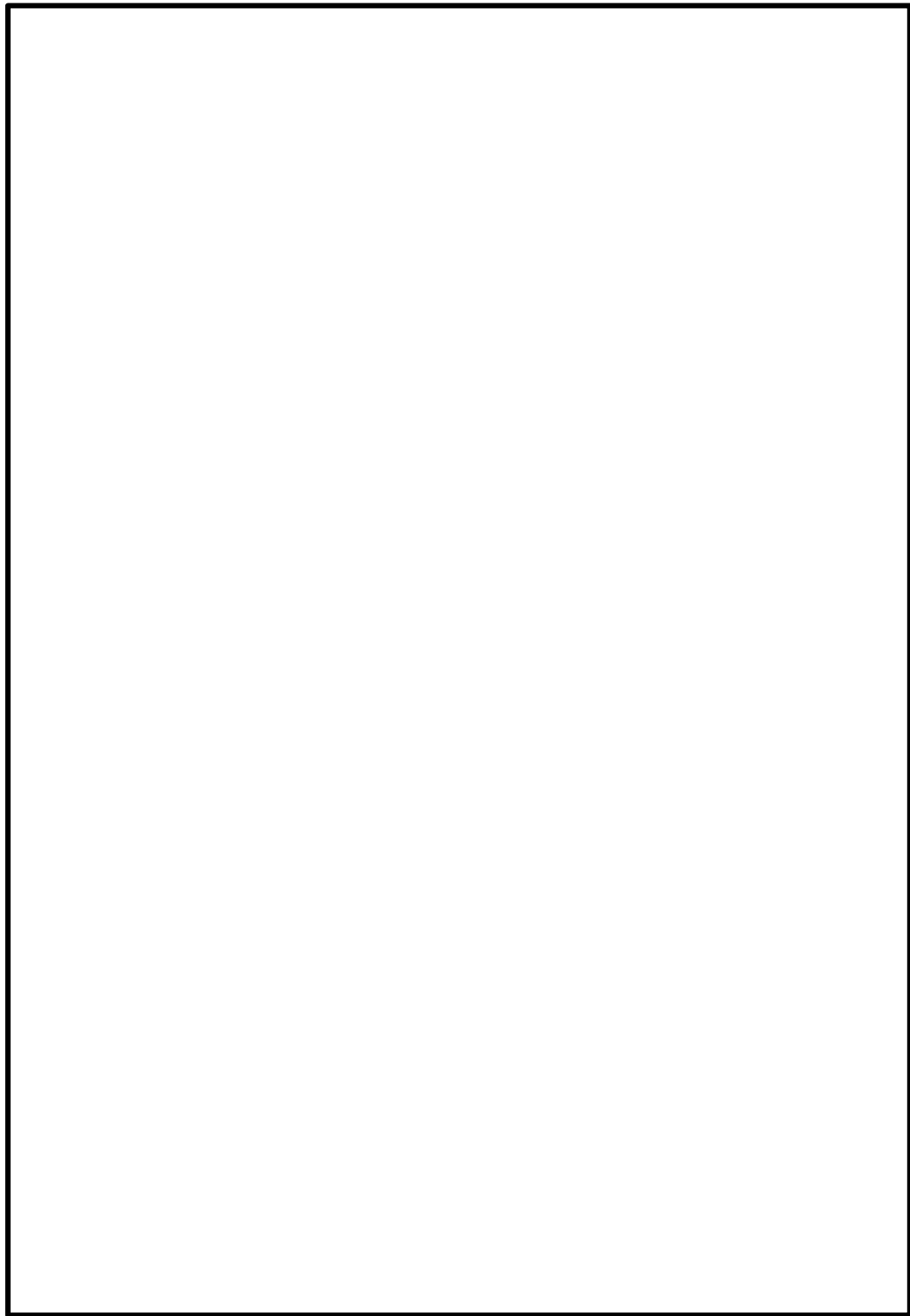
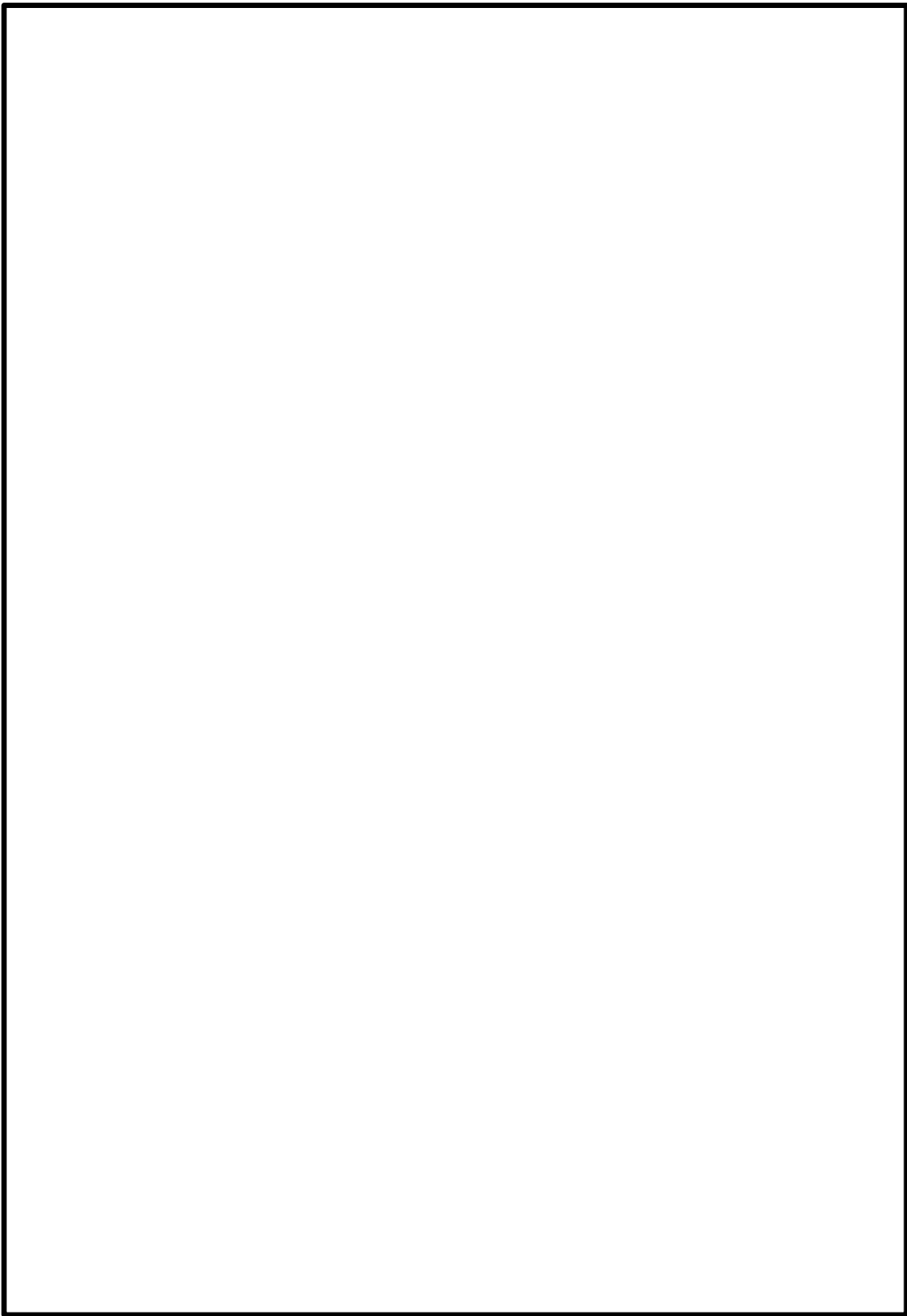

Step 4

A. Complete!

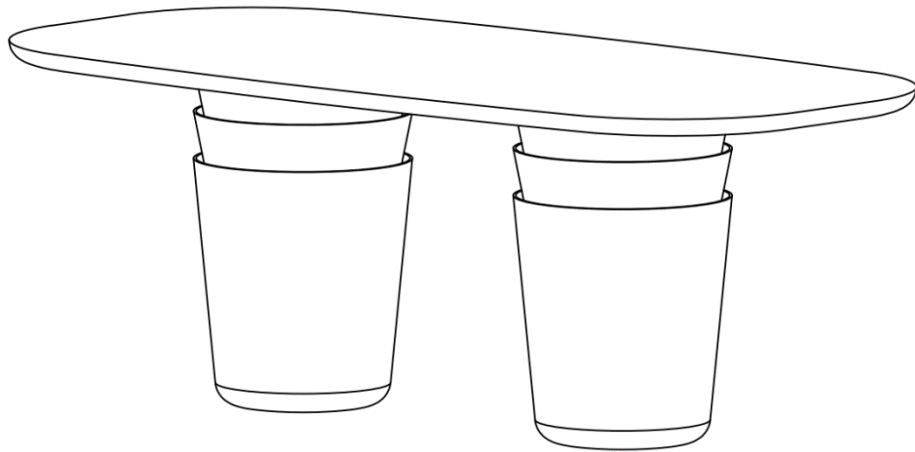

Stuck?

Contact our team @ 516-888-3355

Scan for product care!



Hardware and Components



..... (A) Top x 1pcs



..... (B) Base x 2pcs



..... (C) Bolt M8*20 x 24pcs



..... (D) Washer $\varnothing 22*2$ x 16pcs



..... (E) Allen Key x 2pcs

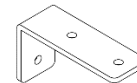

..... (F) Bass x 8pcs

Step 1

Open box of hardware and legs.

This hardware box will be a smaller box inside of the main box. Look for the red streamer.



Step 2

- A - Place table base (B) on the floor.
- B - Using hardware (C, D, E), fix the bass (F) to the table base (B) as shown below.

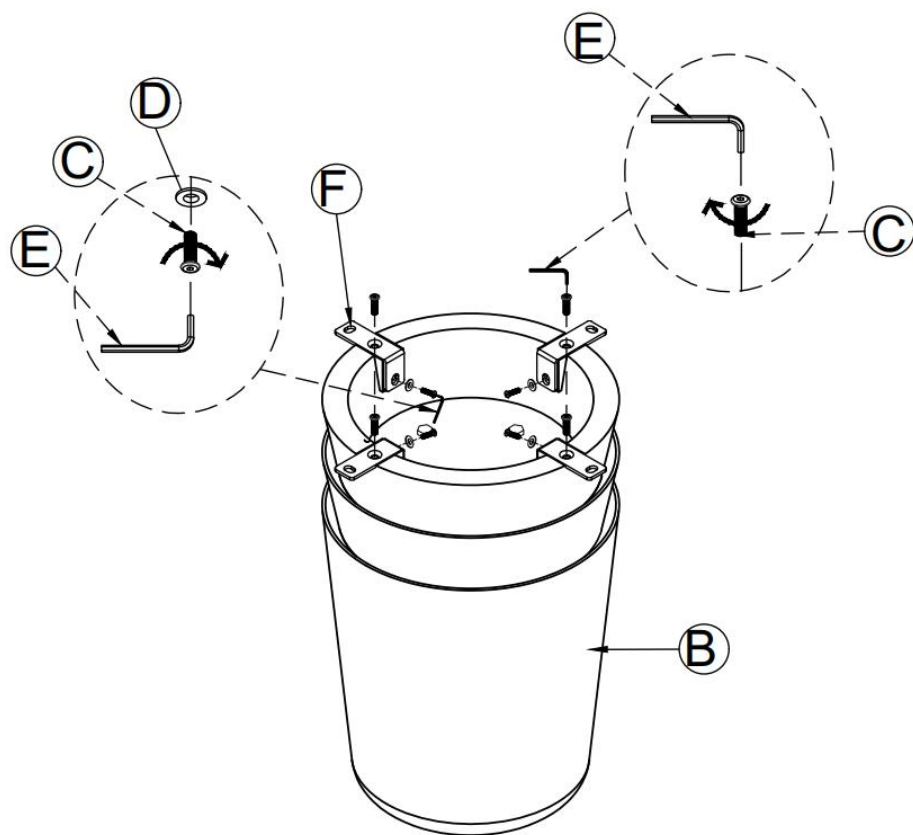

Step 3

- A - Place table base (B) on the floor.
- B - Align table top (A) on top of the table base. Carefully align the holes in the table base to the table top
- C - Using hardware (C, D, E) secure the table top (A) to the Table base (B) as shown below.

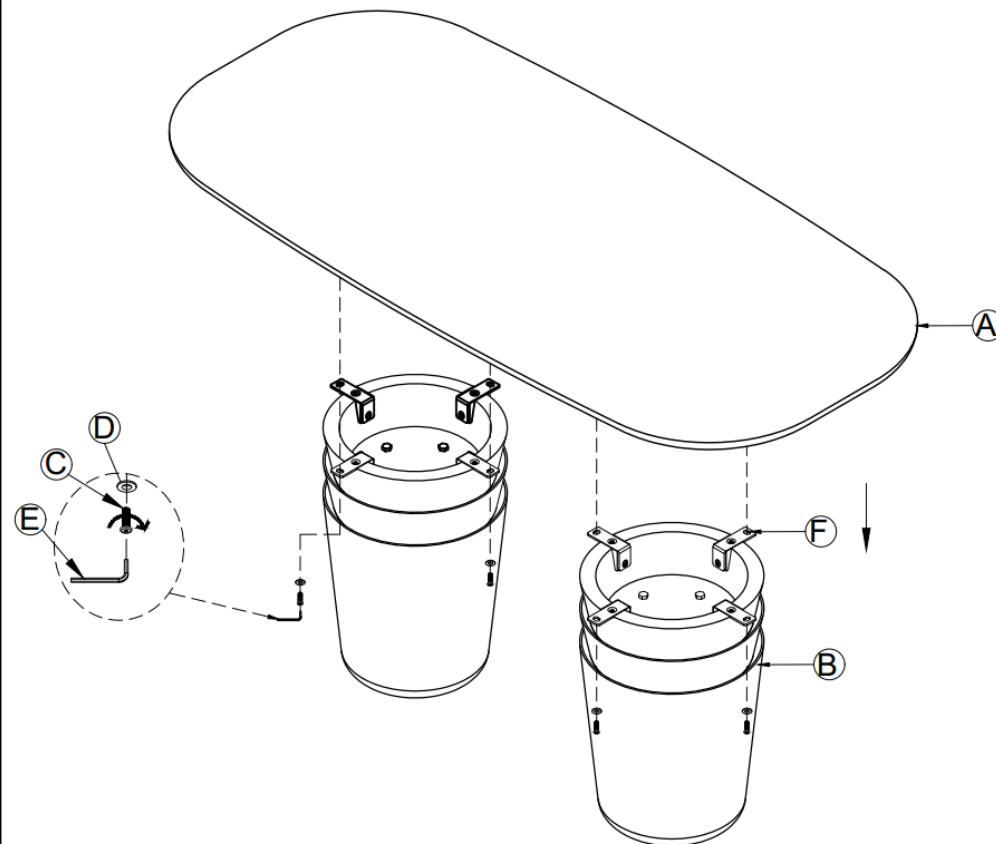

**Please first secure all screws/bolts at 70%
before fully tightening**