

T O V

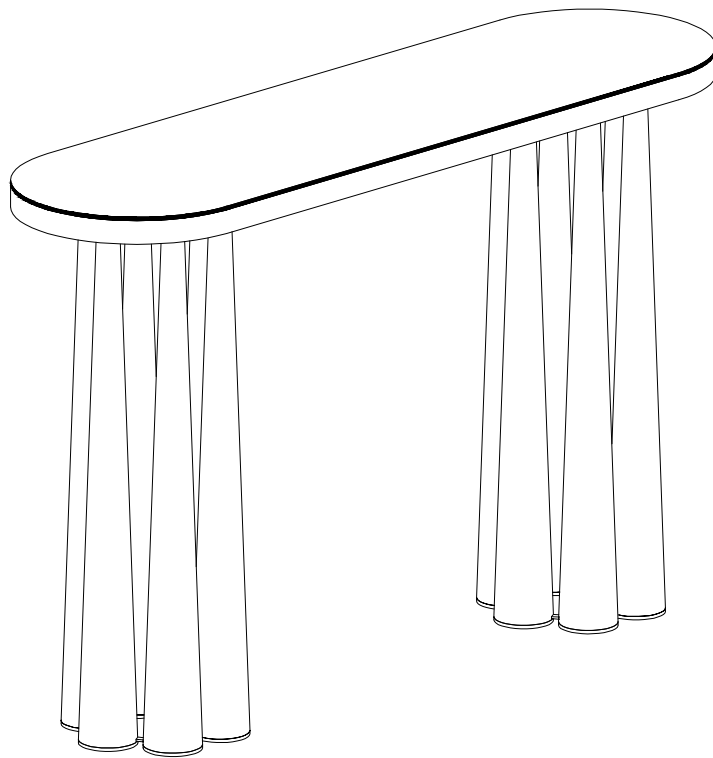

Titan Console Table

DON'T BE BORING.

Hardware and Components

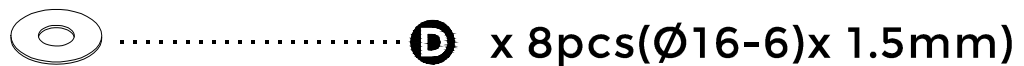
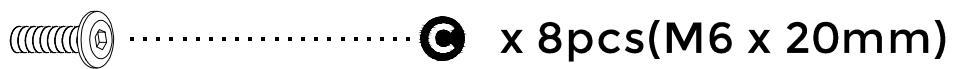
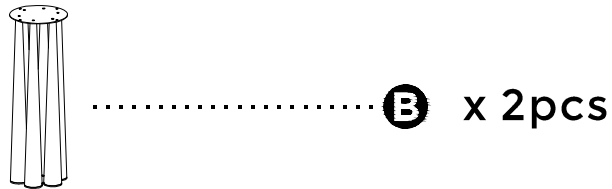

Step 1

Open box of legs.

Look for a hardware bag in the top box. The hardware package has a red streamer.

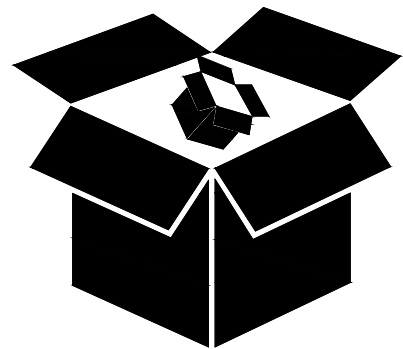

Step 2

A. Tip table over

B. Attach Leg (part B) to table top(part A) using parts C and D

C. Repeat 2x, for both legs

D. Lightly tighten with Allen Key(part E) tool

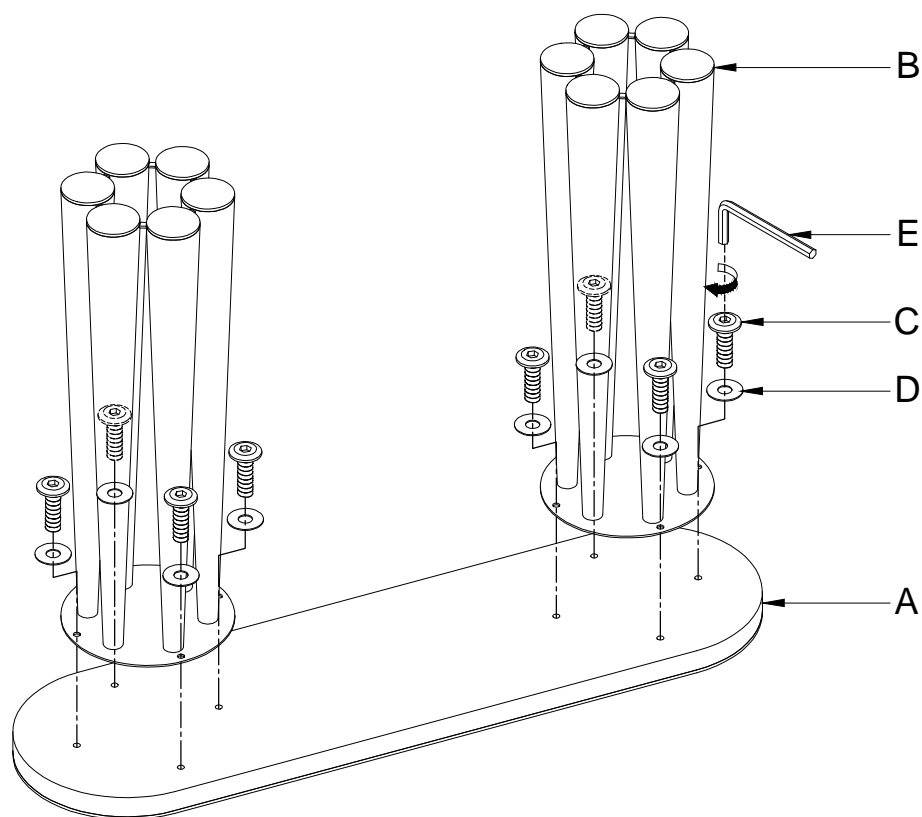

Step 3

A. Tip table over so it is standing in the upright position

B. Attach table to wall using part, F

C. Complete!

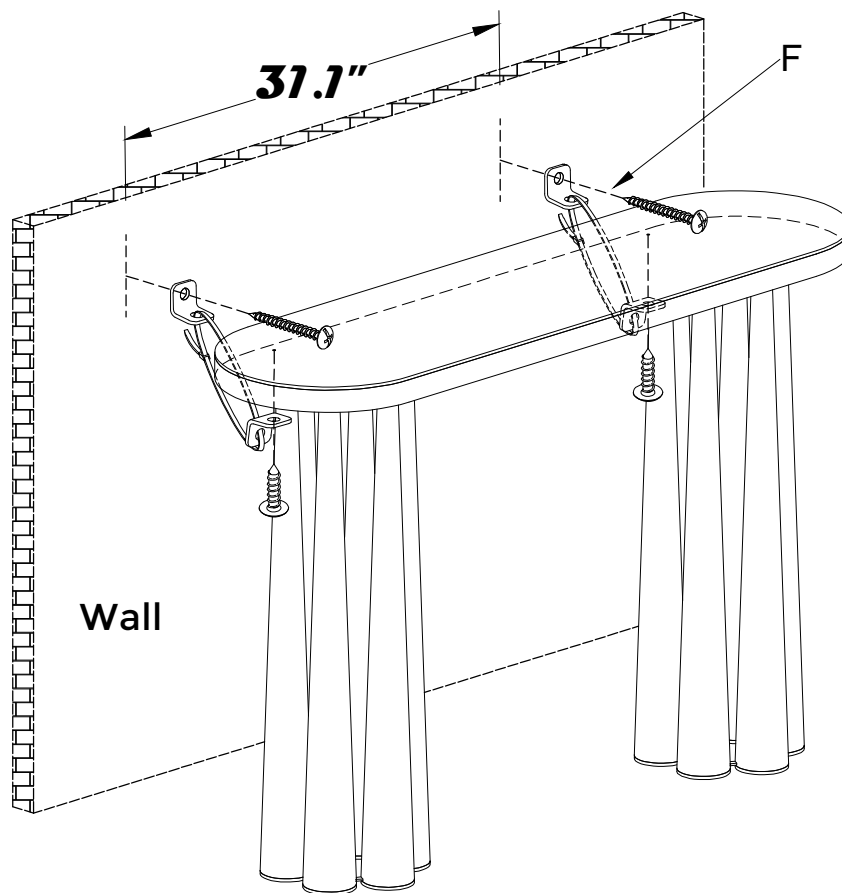

Stuck?
Contact our team @ 516-888-3355

Scan for product care!



TOV



Follow us!

Show your new purchase some love by tagging it on our instagram!

 [@tovfurniture](https://www.instagram.com/tovfurniture)

 516-888-3355

 hello@tovfurniture.com

 www.tovfurniture.com

If the future is female-your furniture should be,too.No mahogany in sight. Sexysettees shaped like lips.Price points for any budget.At TOV,we do things differently.