

# TOV



## Follow us!

Show your new purchase some love by tagging it on our Instagram!

 @tovfurniture

 516-888-3355

 hello@tovfurniture.com

 www.tovfurniture.com

If the future is female—your furniture should be, too. No mahogany in sight. Sexy settees shaped like lips. Price points for any budget. At TOV, we do things differently.

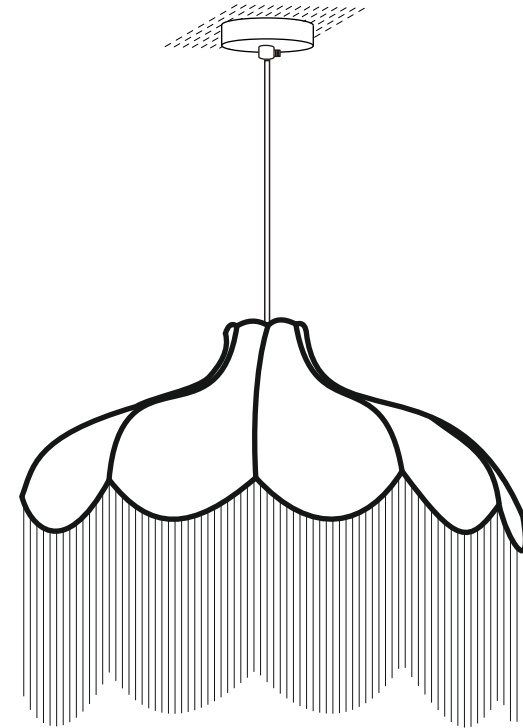

# TOV



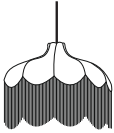

## Buchanan Jute Fringed Scalloped Pendant Light

**DON'T BE BORING.**



# Hardware and Components

A		Pendant	1 Pcs.
B		Ceiling Cap	1 Pcs.
C		Bracket	1 Pcs.

## Hardware List

H-1		Long Screw M4 x 40 mm	2 Pcs.
H-2		Small Screw M4 x 16 mm	2 Pcs.
H-3		Connector	3 Pcs.

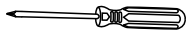
## Tool List

T-1		Phillips Screwdriver	Not Included
T-2		Electrical Tape	Not Included

### STEP-1

- NOTE: Ensure that all wires are threaded through the center hole of Bracket (C) before proceeding.
- Connect the White Wire to the fixture's White Neutral Wire. Connect the Green/Yellow or Copper Ground Wire to the fixture's Green Ground Wire. Connect the Black/Brown Wire to the fixture's Black-Live Wire.
- Fasten each connection together by inserting both ends of the paired wires into a Plastic Wire Cap Connector (H-3) and twisting until you feel resistance. Wrap the connections with Electrical Tape (T-2, not included), and be sure no wire strands are exposed.

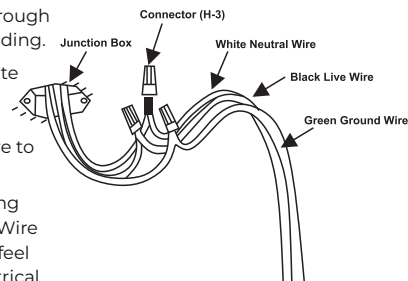

### STEP-2

- Align holes on the Bracket (C) over the junction box and secure it with Long Screw (H-1) using Phillips Screwdriver (T-1, not included).

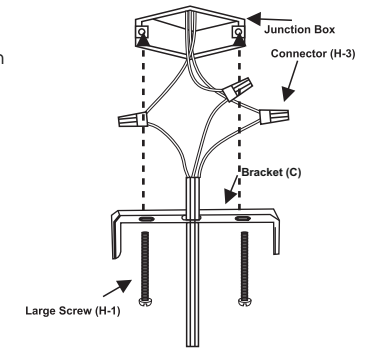

### STEP-3

- Place the Ceiling Cap (B) over Bracket (C) so that the side holes align with one another as shown. Insert Small Screw (H-2) into the side holes and tighten with a Phillips Screwdriver (T-1, not included).
- Check your work and ensure that all connections have been fully tightened.

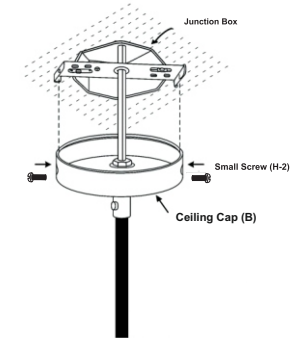

### WARNING ⚠

- To reduce the risk of fire, a **Max. 40 watt type A or 12 watt SB LED** recommended.
- Never turn on the power to the lamp until the light bulb has been installed and assembly is completed.

### Care & Maintenance

- Do not use polishers or cleaners on the lamp.
- Use dry cloth to clean.

Stuck?

Contact our team @ 516-888-3355

Scan for product care!

