

TOV



Follow us!

Show your new purchase some love by tagging it on our Instagram!

 @tovfurniture

 516-888-3355

 hello@tovfurniture.com

 www.tovfurniture.com

If the future is female—your furniture should be, too. No mahogany in sight. Sexy settees shaped like lips. Price points for any budget. At TOV, we do things differently.

TOV



Restis Square Coffee Table

DON'T BE BORING.

Hardware and Components

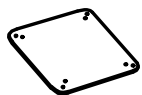

Ⓐ X 1 PC



Ⓑ X 4 PCS LEGS



Ⓒ X 8 PCS (Ø5/16"x387mm)



Ⓓ X 8 PCS

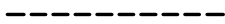

Ⓔ X 8 PCS



Ⓕ X 1 PC

Step 1

Open box of hardware and legs.

The hardware is packed in the small plastic bag inside the leg box, carton #2.
Look for the red streamer.

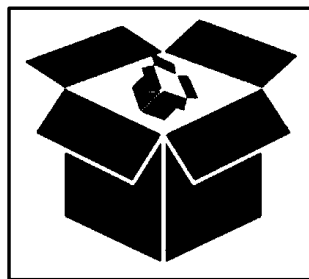

Step 2

- Place the Table Top (A) face upside down on a clean, non-marring surface (i.e. packing foam)
- Tighten Bolt (C) into the threaded nuts on the backside of Table Top (A).
- Align the Leg (B) into the Bolt (C) as illustrated.

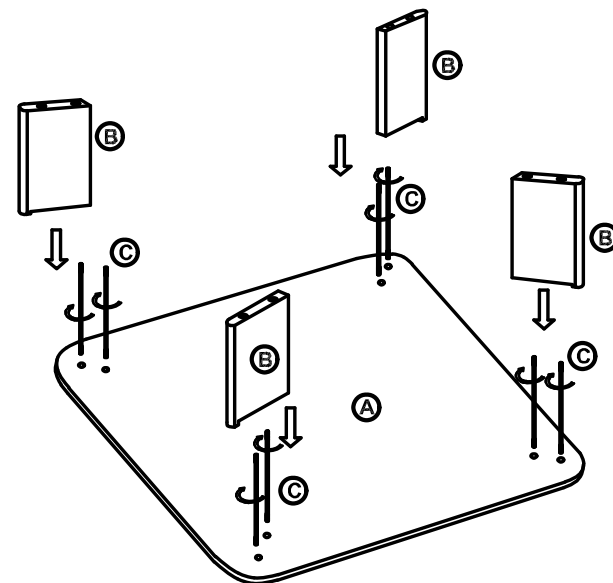

Step 3

- A. Tighten the Leg (B) by using Nut (D) Washer (E) and Wrench (F).
- B. Repeat 4x, for all 4 legs.

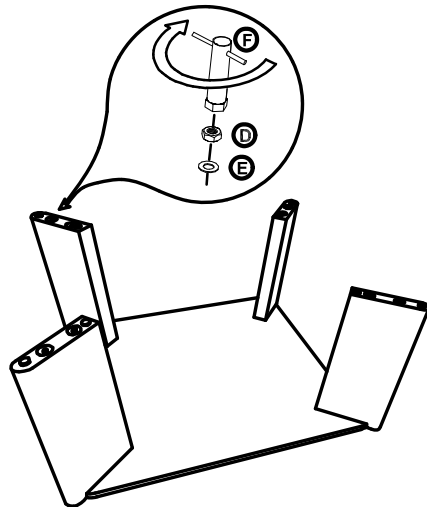

Step 4

- A. With help, turn the table over, so it is standing in the upright position.
- B. Complete.

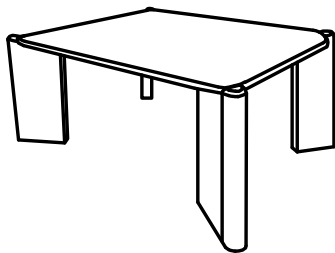

Stuck?
Contact our team @ 516-888-3355

Scan for product care!

